





**Industrial Cellular VPN Router
NR500 Standard User Manual
20101011 & 20101012**



REVISION HISTORY

Revision	Date	Revision Details
0	May 2018	Initial release.
1	Aug 2018	Add Schedule Reboot, OpenVPN, IPSec
2	Oct 2018	Add SSH, GRE, VRRP, Wi-Fi Client

Trademarks and copyright

Guangzhou Navigatworx Technologies Co, Ltd and  &  logo are the trademarks or registered trademarks in China mainland, HongKong and other countries worldwide. All other trademarks mentioned in this document are the property of their respective owners.

@2018 Navigatworx Technologies. All Rights Reserved.

Disclaimers

Information in this document is subject to change without notice and does not represent a commitment on the part of Navigatworx Technologies.

Navigatworx Technologies provides this document as is, without warranty of any kind, either expressed or implied, including, but not limited to, its particular purpose. Navigatworx Technologies may make improvements and/or changes in this manual, or in the product(s) and/or the program(s) described in this manual at any time.

Information provided in this manual is intended to be accurate and reliable. However, Navigatworx Technologies assumes no responsibility for its use, or for any infringements on the rights of third parties that may result from its use.

Technical Support

E-mail: support@navigateworx.com
info@navigateworx.com

Web: www.navigateworx.com

Interference Issues

Avoid possible radio frequency (RF) interference by following these guidelines:

- The use of cellular telephones or devices in aircraft is illegal. Use in aircraft may endanger operation and disrupt the cellular network. Failure to observe this restriction may result in suspension or denial of cellular services to the offender, legal action, or both.
- Do not operate in the vicinity of gasoline or diesel fuel pumps unless use has been approved or authorized.
- Do not operate in locations where medical equipment that the device could interfere with may be in use.
- Do not operate in fuel depots, chemical plants, or blasting areas unless use has been approved and authorized.
- Use care if operating in the vicinity of protected personal medical devices, i.e., hearing aids and pacemakers.
- Operation in the presence of other electronic equipment may cause interference if equipment is incorrectly protected. Follow recommendations for installation from equipment manufacturers.

Declaration of Conformity

NR500 Series products are in conformity with the essential requirements and other relevant provisions of the CE and RoHS.



Table of Contents

Chapter 1.	Product Overview	5
1.1	Overview	5
1.2	Features and Benefits	5
1.3	General Specifications	6
1.4	Mechanical Specifications	8
1.5	Package Checklist.....	9
1.6	Order Information	11
Chapter 2.	Installation	12
2.1	Product Overview	12
2.2	LED Indicators.....	14
2.3	Ethernet Port Indicator.....	15
2.4	PIN Definition of Terminal block	15
2.5	Reset Button.....	16
2.6	Insert SIM card.....	16
2.7	Install Antenna	17
2.8	DIN-rail Mounting.....	18
2.9	Protective Grounding Installation.....	18
2.10	Power Supply Installation	19
2.11	Power On The Router.....	19
Chapter 3.	Access to Web page.....	20
3.1	PC Configuration	20
3.2	Factory Default Settings	21
3.3	Login to Web Page.....	22
Chapter 4.	Web Configuration.....	23
4.1	Web Interface.....	23
4.2	Overview	25
4.2.1	Status	25
4.2.2	Syslog.....	27
4.3	Link Management.....	28
4.3.1	Connection Manager	28
4.3.2	Cellular	31
4.3.3	Ethernet.....	34
4.3.4	Wi-Fi.....	39
4.4	Industrial Interface	44
4.4.1	Serial.....	44
4.4.2	Digital IO	48
4.5	Network.....	50
4.5.1	Firewall.....	50
4.5.2	Route	52
4.5.3	VRRP.....	53
4.6	Applications.....	55
4.6.1	DDNS.....	55
4.6.2	Schedule Reboot	56

4.7	VPN.....	57
4.7.1	OpenVPN	57
4.7.2	IPSec	62
4.7.3	GRE.....	65
4.8	Maintenance	66
4.8.1	Upgrade	66
4.8.2	System	67
4.8.3	Configuration	71
4.8.4	Debug Tools.....	71
Appendix A -Glossary		73
Appendix B -Q&A		74
	No Signal	74
	Cannot detect SIM card	74
	Poor Signal	74
	IPSec VPN established, but LAN to LAN cannot communicate.....	75
	Forget Router Password	75
Appendix C -Digital IO Scenario		76
Appendix D - CLI.....		77

Chapter 1. Product Overview

1.1 Overview

Navigateworx NR500 series industrial cellular VPN router offers a single, flexible platform to address a variety of wireless communications needs with over-the-air configuration and system monitoring for optimal connectivity. This router enables wireless data connectivity over public and private LTE cellular networks at 4G speeds.

NR500 series router has dual SIM backup, 2 or 4 LAN ports, 1 port could be changed to Ethernet WAN connection (for fixed internet fail over to cellular). An optional 802.11 b/g/n Wi-Fi interface access point and client operations supports connectivity to IP applications in a variety of different connection scenarios. RS232 and RS485 interfaces are provided to support Serial to IP communication. NR500 series router also support 2 x digital input and 2 x Digital output for alarm applications.

NR500 series router supports 9 to 48 VDC wide range power inputs, designed with reverse-voltage protection mechanism for greater reliability. It is an advanced choice for universal wireless M2M applications with reliable features for data transmission.

1.2 Features and Benefits

Industrial internet access

- Wireless Mobile Broadband 2G / 3G / 4G Connection
- Remote access to SCADA System for Industrial Automation
- Reduce high costs for on-site maintenance

Designed for industrial usage

- Power Input Range 9 to 48 VDC
- Industrial designed for harsh environment
- Compact metal casing for easy mounting

Secure and reliable remote connection

- Connection manager ensure seamless communication
- Support Multiple VPN tunnels for data encryption
- Firewall prevents unsafe and unauthorized access

Easy to use and easy maintenance

- User-friendly web interface for human interaction
- Easy configuration for deployment
- Support 3rd Party remote management cloud

1.3 General Specifications

Cellular Interface

- Standards: FDD-LTE/TDD-LTE, WCDMA/UMTS/HSPA/HSPA+/EDGE/GPRS,
- 2× SMA female antenna connector
- 2 x SIM (3.0V & 1.8V)

Wi-Fi Interface (Optional)

- Standards: 802.11b/g/n, 300Mbps
- 2 x RP-SMA male antenna connector
- Support Wi-Fi AP and Client modes
- Security: WEP, WPA and WPA2 encryption
- Encryption: AES, TKIP, WEP64

Ethernet Interface

- Standard: IEEE 802.3, IEEE 802.3u
- Number of Ports:
NR500-Standard: 2 x 10/100 Mbps, RJ45 connector
NR500-Pro: 4 x 10/100 Mbps, RJ45 connector
- 1 x WAN interface (configurable on Web GUI)
- 1.5KV magnetic isolation protection

Serial Interface

- 1×RS232 (3 PIN): TX, RX, GND
- 1 x RS485 (2 PIN): Data+(A), Data-(B)
- Baud rate: 300 bps to 115200 bps
- Connector: terminal block
- 15KV ESD protection

DI/DO Interface

- Type: 2 x DI + 2 x DO
- Connector: terminal block
- Isolation: 3KVDC or 2KVrms
- Absolute maximum VDC: 36VDC
- Absolute maximum ADC: 100mA

Other Interfaces

- 1× RST button
- LED instruction: 1 x SYS, 1 x NET, 1 x USR, 3 x RSSI

Software

- Network protocols: DHCP, ICMP, PPPoE, HTTP, HTTPS, DNS, VRRP, NTP...
- VPN: IPSec, PPTP/L2TP client, GRE, OpenVPN, DMVPN
- Policy: RIPv2/OSPF/BGP dynamic route (optional)
- Firewall & Filter: Port forwarding, DMZ, anti-DoS, ACL
- Serial port: TCP server and client, UDP
- Management: Web, SNMP, 3rd party platform

Power Supply and Consumption

- Connector: 3-pin 3.5 mm female socket with lock
- Input voltage range: 9~48VDC
- Power consumption:
Idle: 100 mA@12V
Data link: 400 mA (peak) @12V

Physical Specification

- Ingress Protection: IP30
- Housing & Weight: Metal, 300g
- Dimension: 104mm x 104mm x 38mm (excluding antenna)
- Installations: Din-rail mounting

Environmental

- Operation temperature: -40~+75°C
- Store temperature: -40~+85°C
- Operation humidity: 5% to 95% non-condensing

1.4 Mechanical Specifications

Dimension: 104mm x 104mm x 38mm (excluding antenna)

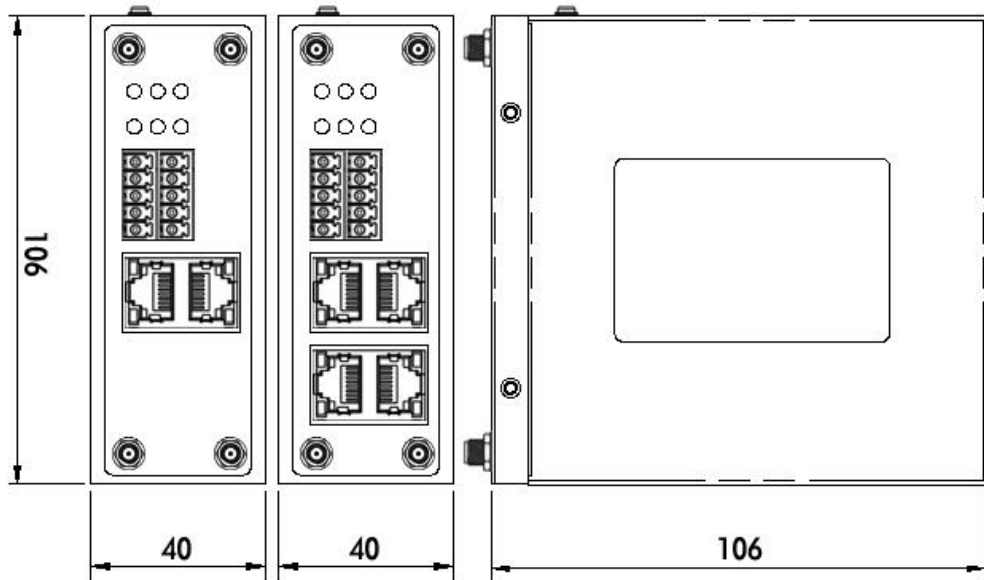
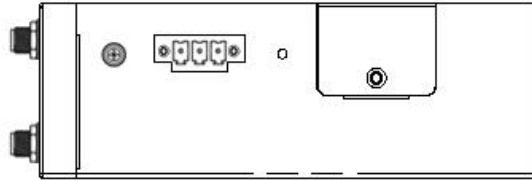

1.5 Package Checklist

NR500 series Router includes the parts shown in below, please verify your components.

NOTE: if any of the below items is missing or damaged, please contact your sales representative.

Included equipment

- 1 x Navigateteworx NR500 series Industrial Cellular VPN router (Wi-Fi optional)

NR500 Standard

NR500 Pro

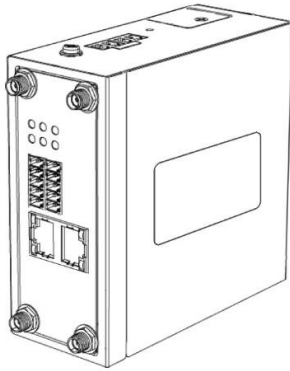

or

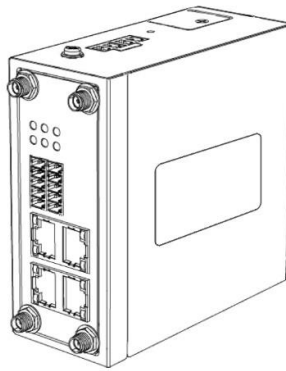

- 1 x 3-pin 3.5 mm male terminal block with lock for power supply

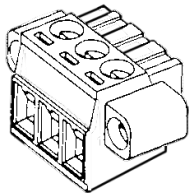

- 1 x 10-pin 3.5 mm male terminal block for RS232/RS485/DI/DO

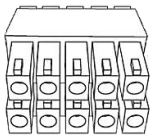

- 1 x Ethernet cable



- 1 x Quick Start Guide



Optional Accessories (sold separately)

- 3G/4G cellular antenna
Stubby antenna



Magnet antenna
20101174

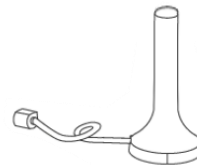

- RP-SMA Wi-Fi antenna
Stubby antenna
20101173



Magnet antenna



- 35mm Din-rail mounting kit
20101175

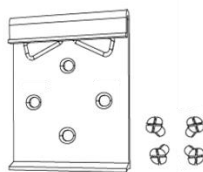

- AC/DC power adapter (12VDC, 1.5A; EU/US/UK/AU plug optional)

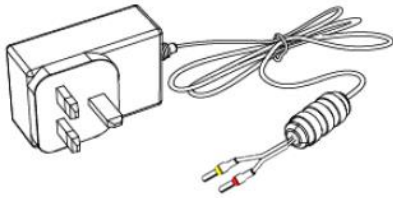

1.6 Order Information

Model	Part Number	Description
NR500-S4G	A502433 20101011	4G LTE, Dual SIMs, 2 x Eth, 1 x RS232 (3 PIN), 1 x RS485, 2 x DI, 2 x DO, 9 - 48VDC
	A512433 20101012	4G LTE, Dual SIMs, 2 x Eth, 1 x RS232 (3 PIN), 1 x RS485, 2 x DI, 2 x DO, 9 - 48VDC, 2.4GHz Wi-Fi
NR500-S3G	A502333	3G, Dual SIMs, 2 x Eth, 1 x RS232 (3 PIN), 1 x RS485, 2 x DI, 2 x DO, 9 - 48VDC
	A512333	3G, Dual SIMs, 2 x Eth, 1 x RS232 (3 PIN), 1 x RS485, 2 x DI, 2 x DO, 9 - 48VDC, 2.4GHz Wi-Fi
NR500-P4G	A504433 20101022	4G LTE, Dual SIMs, 4 x Eth, 1 x RS232 (3 PIN), 1 x RS485, 2 x DI, 2 x DO, 9 - 48VDC
	A514433 20101023	4G LTE, Dual SIMs, 4 x Eth, 1 x RS232 (3 PIN), 1 x RS485, 2 x DI, 2 x DO, 9 - 48VDC, 2.4GHz Wi-Fi
NR500-P3G	A504333	3G, Dual SIMs, 4 x Eth, 1 x RS232 (3 PIN), 1 x RS485, 2 x DI, 2 x DO, 9 - 48VDC
	A514333	3G, Dual SIMs, 4 x Eth, 1 x RS232 (3 PIN), 1 x RS485, 2 x DI, 2 x DO, 9 - 48VDC, 2.4GHz Wi-Fi

Chapter 2. Installation

2.1 Product Overview

- Front Panel

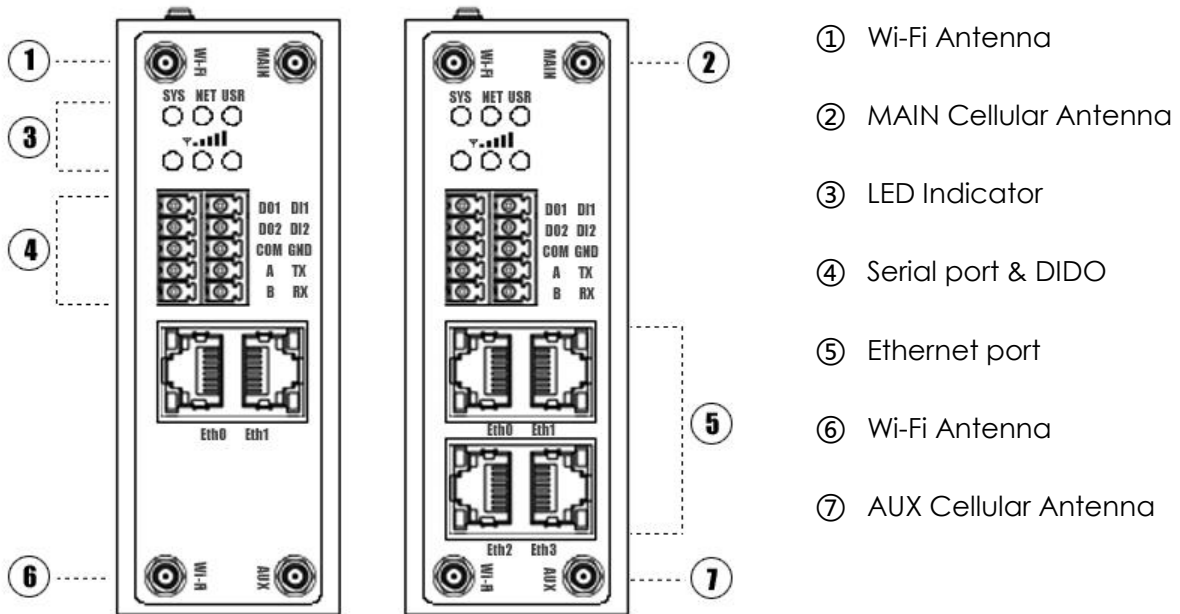

- Left Side Panel

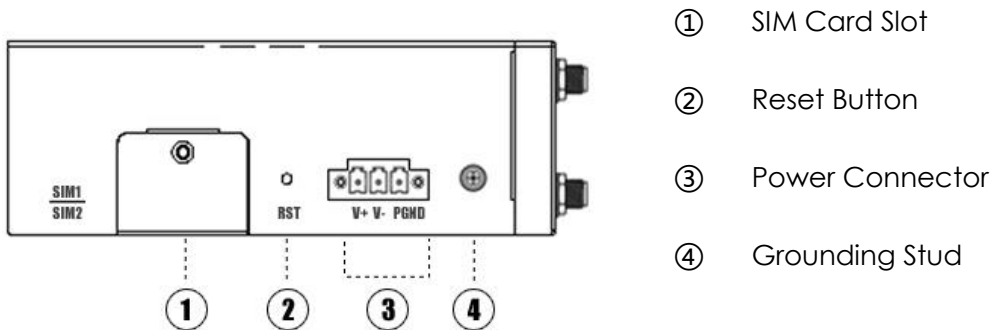

2.2 LED Indicators

Name	Color	Status	Description
SYS	Green	Slow Blinking (500ms duration)	Operating normally
		Fast Blinking	System initialing
		Off	Power is off
NET	Green	On	Register to Highest priority network service (depend on Radio, e.g. Radio support LTE as Highest priority network).
		Fast Blinking (250ms duration)	Register to Non-Highest priority network service (depend on Radio, e.g. Radio support LTE as Highest priority network, then WCDMA and GPRS is non-highest priority network).
		Off	Register failed
USR: SIM	Green	On	Router is trying cellular connection with SIM1
		Fast Blinking (250ms duration)	Router is trying cellular connection with SIM2
		Off	No SIM detected
USR: Wi-Fi	Green	On	Wi-Fi is enabled and data transmission
		Off	Wi-Fi is disable or initialize failed
Signal Strength Indicator 	Green	On, 3 LED light up	Signal strength (21-31) is high
		On, 2 LED light up	Signal strength (11-20) is medium
		On, 1 LED light up	Signal strength (1-10) is low
		Off	No signal

2.3 Ethernet Port Indicator

Name	Status	Description
Link indicator	On	Connection is established
	Blinking	Data is being transmitted
	Off	Connection is not established

NOTE: There are two LED indicators for each Ethernet port. Due to the chipset design NR500 router would only light up the green one(Link indicator) on left side, the right LED is Off without meaning.

2.4 PIN Definition of Terminal block

- Serial Port & DIDO



PIN	RS232	RS485	DI	DO	Direction
1	--	--	--	DO1	Router-->Device
2	--	--	--	DO2	Router-->Device
3	--	--	--	COM	--
4	--	A	--	--	Router<-->Device
5	--	B	--	--	Router<-->Device
6	--	--	DI1	--	Router<--Device
7	--	--	DI2	--	Router<--Device
8	GND	--	--	--	--
9	TX	--	--	--	Router-->Device
10	RX	--	--	--	Router<--Device

• **Power Input**



PIN	Description
V+ (Red line)	Positive
V- (Yellow line)	Negative
PGND	GND

2.5 Reset Button

Function	Action
Reboot	Press the RST button within 3s under operation status
Factory Reset	Press the RST button between 3s to 10s, all LED blink few times then reboot automatically.

2.6 Insert SIM card

• **Insert / Remove SIM card**

1. Make sure the power is disconnected.
2. Use a Philips-head screwdriver to remove SIM slot cover.
3. Insert the SIM card(s) in to the SIM sockets.
4. Replace the SIM slot cover.

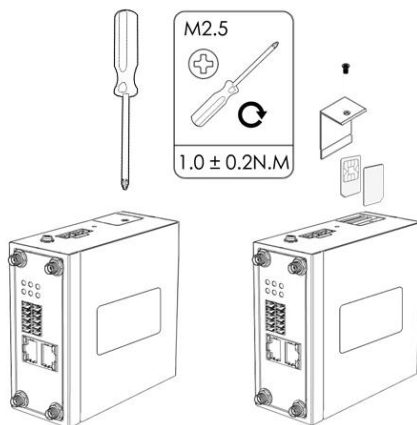

2.7 Install Antenna

- Connect the cellular antenna to the MAIN and AUX connector on the unit.

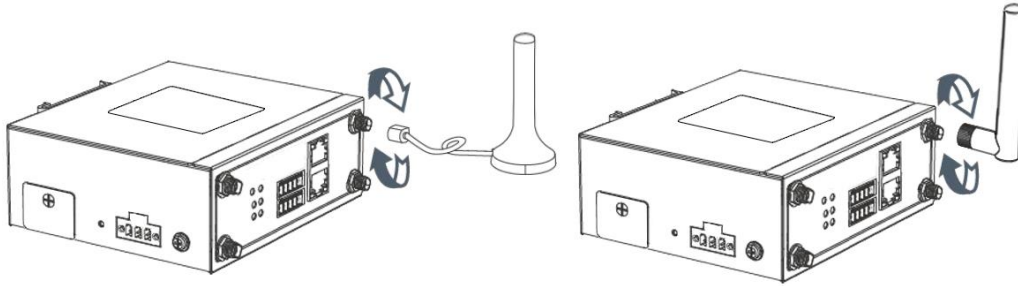

NOTE: NR500 router supports dual antennas with MAIN and AUX connectors. MAIN connector is for data receiving and transmission. AUX connector is for enhancing signal strength, which cannot be used separately.

- Connect the Wi-Fi antenna to the Wi-Fi connector on the unit.

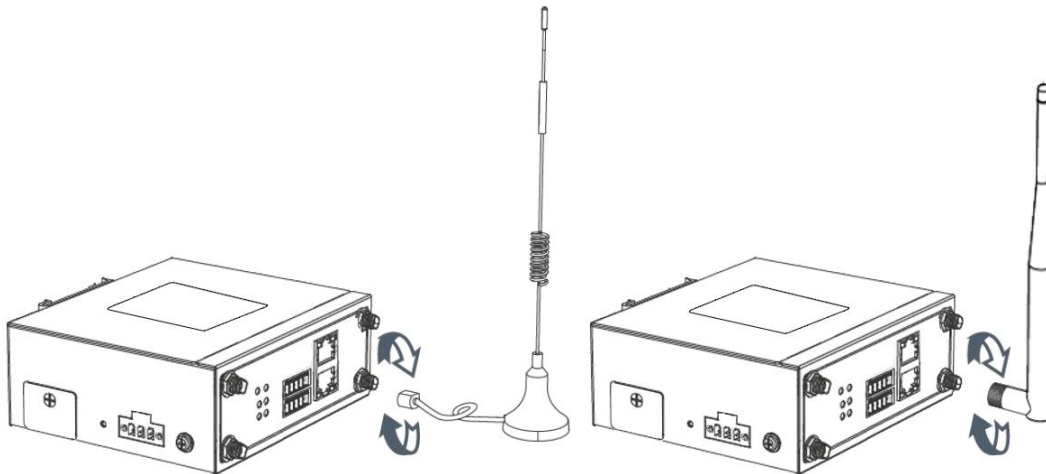

2.8 DIN-rail Mounting

1. Use 4 pcs of M3x6 flat head phillips screws to fix the DIN-rail to the router.
2. Insert the upper lip of the DIN-rail into the DIN-rail mounting kit.
3. Press the router towards the DIN-rail until it snaps into place.

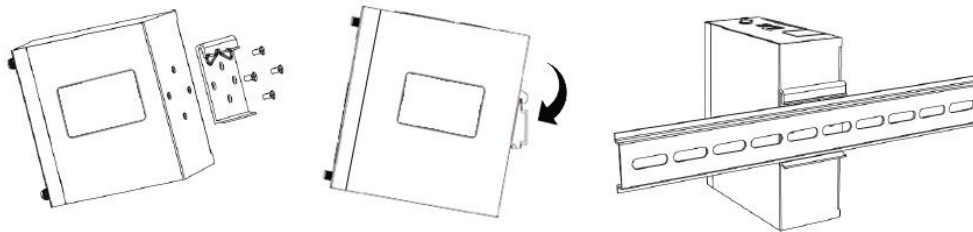
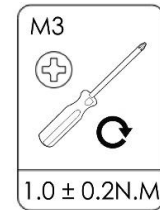

2.9 Protective Grounding Installation

1. Remove the grounding nut.
2. Connect the grounding ring of the cabinet's grounding wire onto the grounding stud and screw up the grounding nut.

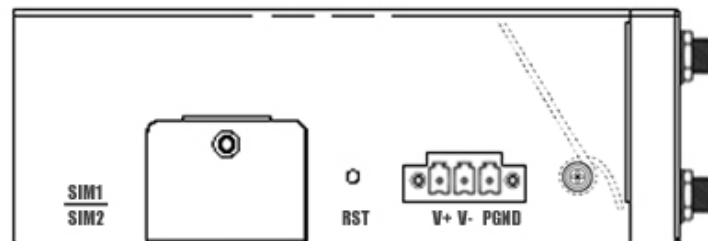

NOTE: Strongly recommended the router to be grounded when deployed.

2.10 Power Supply Installation

1. Remove the pluggable connector from the unit, then loosen the screws for the locking flanges as needed.
2. Connect the wires of the power supply to the terminals.

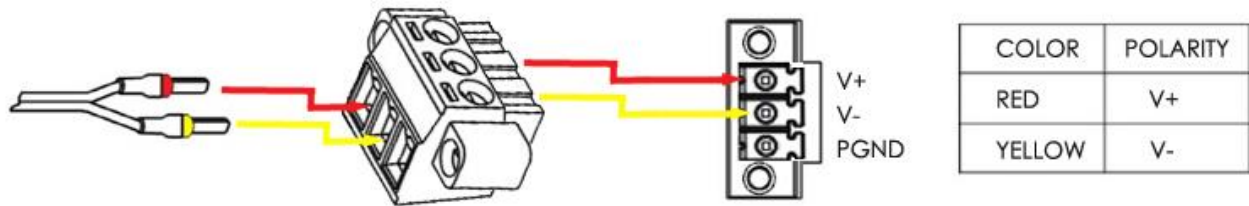

2.11 Power On The Router

1. Connect one end of the Ethernet cable to the LAN port on the unit and the other end to a LAN port on a PC.
2. Connect the AC power to a power source.
3. Router is ready when SYS LED is blinking.

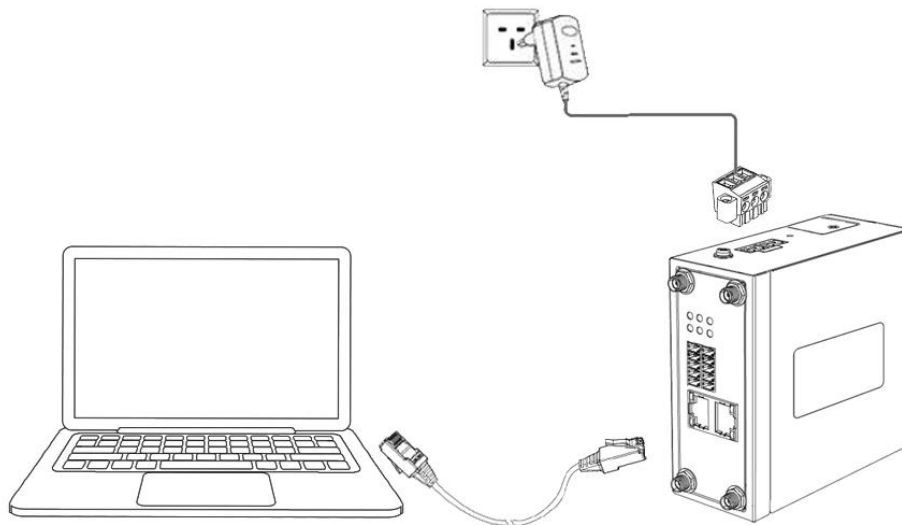

Chapter 3. Access to Web page

3.1 PC Configuration

NR500 router contains a DHCP server which will automatically assign an IP address to your PC, however in some cases the user may need to change the network settings on their PC to accept the IP address from the NR500. or you can configure a static IP address manually.

- **Obtain an IP address automatically**

The process required to do this differs depending on the version of Windows you are using.

NOTE: The following steps are based on Windows 7.

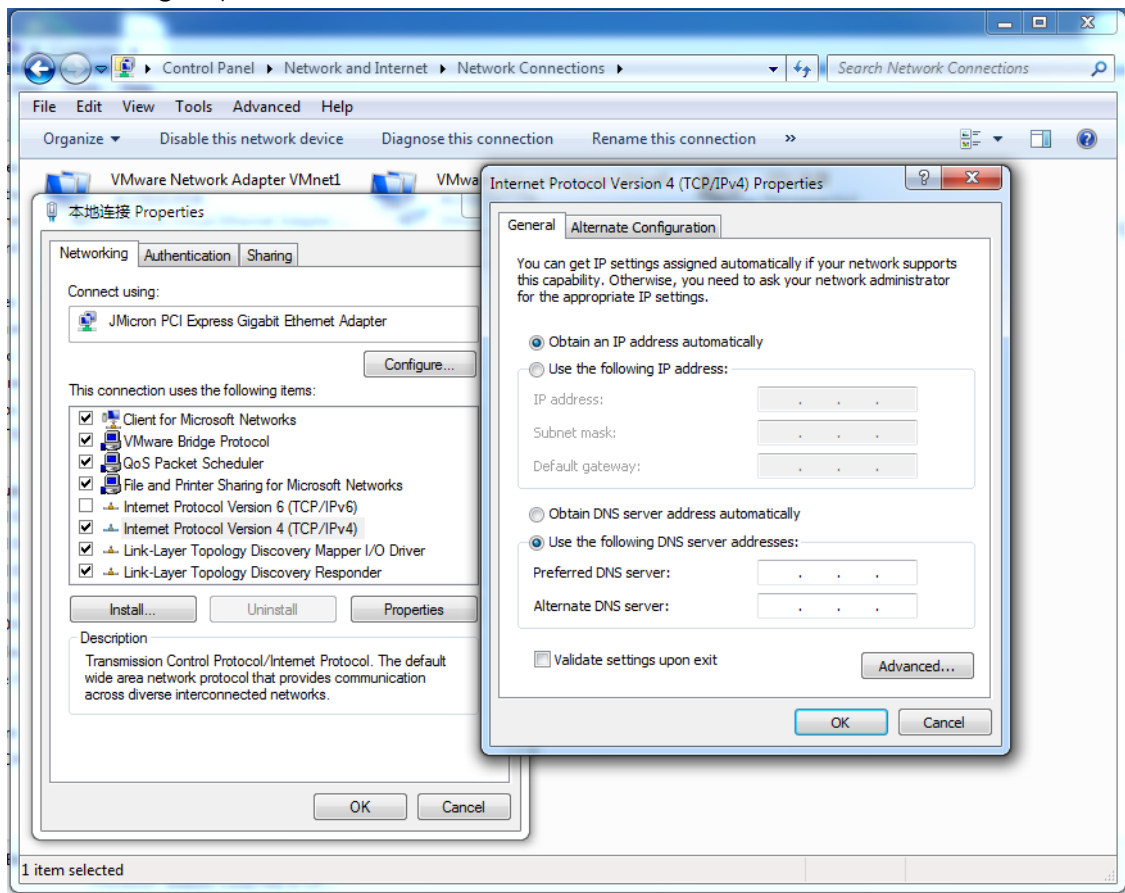

select **Start » Control Panel » Network Connections**. Right click **Local Area Connection** and select **Properties** to open the configuration dialog box for Local Area Connection. Select **Internet Protocol (TCP/IP)** and click **Properties** to open the TCP/IP configuration window. On the General tab, select **Obtain an IP address automatically** and **Obtain DNS server address automatically**. Click **OK** to complete TCP/IP configuration.

- **Set to a static IP address**

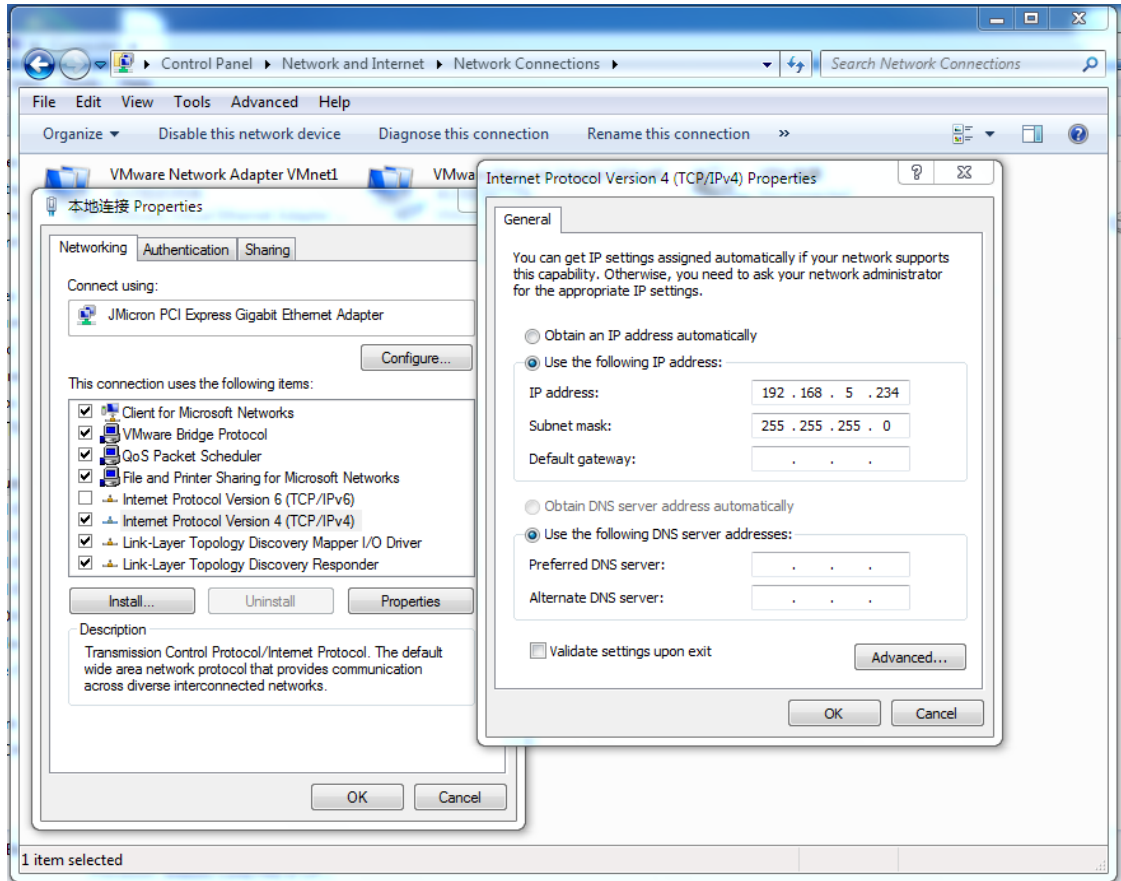

click "**Use the following IP address**" to assign a static IP manually within the same subnet of the router.

NOTE: *Default gateway* and *DNS server* is not necessary if PC not routing all traffic go through NR500 router.

3.2 Factory Default Settings

NR500 router supports Web-based configuration interface for management. If this is the first time for you to configure the router, please refer to below default settings.

Username: **admin**

Password: **admin**

LAN IP Address: **192.168.5.1** (Eth0~Eth1/Eth3 bridge as LAN mode)

DHCP Server: **Enabled**

3.3 Login to Web Page

1. Start a Web browser on your PC (Chrome and IE are recommended), enter 192.168.5.1 into the address bar of the web browser.
2. Then use the default username and password(admin/admin), to log in to the router.

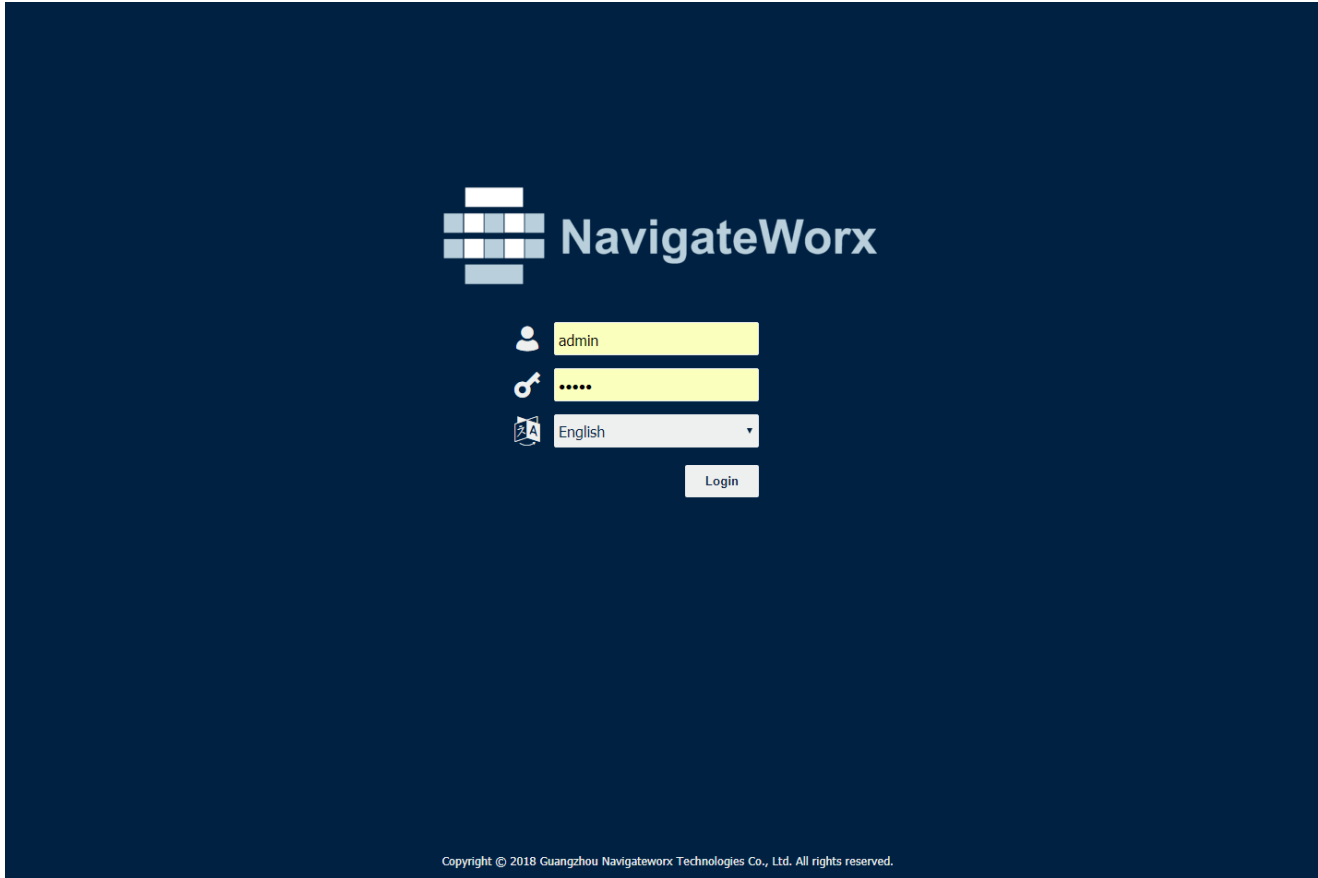

Chapter 4. Web Configuration

4.1 Web Interface

The NR500 router Web interface is divided into two sections. In the left pane is the main navigation menu. On the right is the content area for each page.

The screenshot shows the NavigateWorx web interface. On the left is a dark blue navigation menu with the following items: Overview (with a sub-item 'Syslog'), Link Management, Industrial Interface, Network, Applications, VPN, and Maintenance. The main content area is titled 'Status' and contains two sections: 'System Information' and 'Active Link Information'. The 'System Information' section lists: Device Model (NR500 Pro 3G/4G Router), System Uptime (00:50:09), System Time (2018-08-20 10:38:19), RAM Usage (46M Free/64M Total), Firmware Version (V1.0.0), Kernel Version (4.4.92), and Serial Number (11222018080001). The 'Active Link Information' section lists: Link Type (WWAN1), IP Address (10.160.245.8), Netmask (255.255.255.240), Gateway (10.160.245.9), Primary DNS Server (120.80.80.80), and Secondary DNS Server (221.5.88.88). At the top right of the interface, it shows 'Login: admin' and buttons for 'Reboot' and 'Logout'. At the bottom of the interface, there is a copyright notice: 'Copyright © 2018 Guangzhou Navigateworx Technologies Co., Ltd. All rights reserved.'

System Information	
Device Model	NR500 Pro 3G/4G Router
System Uptime	00:50:09
System Time	2018-08-20 10:38:19
RAM Usage	46M Free/64M Total
Firmware Version	V1.0.0
Kernel Version	4.4.92
Serial Number	11222018080001

Active Link Information	
Link Type	WWAN1
IP Address	10.160.245.8
Netmask	255.255.255.240
Gateway	10.160.245.9
Primary DNS Server	120.80.80.80
Secondary DNS Server	221.5.88.88

NOTE: The navigation menu may contain fewer sections than shown here depending on which options are installed in your unit.

- **Reboot:** reset the router within power disconnect.
- **Logout:** logout to web authorization page.



- **Save:** save the configuration on current page.
- **Apply:** apply the changes on current page immediately.



- **Close:** exit without changing the configuration on current page.

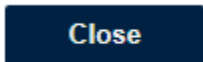

4.2 Overview

4.2.1 Status

You can view the system information of the router on this page.

Status	
System Information	
Device Model	NR500 Standard 3G/4G Router
System Uptime	00:49:52
System Time	2018-08-17 20:42:35
RAM Usage	46M Free/64M Total
Firmware Version	V1.0.0
Kernel Version	4.4.92
Serial Number	00000118070001

System Information

- **Device Module**
Displays the model name of router
- **System Uptime**
Displays the duration the system has been up in hours, minutes and seconds.
- **System Time**
Displays the current date and time.
- **RAM Usage**
Displays the RAM capacity and the available RAM memory.
- **Firmware Version**
Displays the current firmware version of router.
- **Kernel Version**
Displays the current kernel version of router.
- **Serial Number**
Display the serial number of router.

Active Link Information

Link Type	WAN
IP Address	192.168.111.33
Netmask	255.255.255.0
Gateway	192.168.111.1
Primary DNS Server	192.168.129.1
Secondary DNS Server	192.168.111.1

Active Link Information

- **Link Type**
Current interface for internet access.
- **IP Address**
Displays the IP address assigned to this interface.
- **Netmask**
Displays the subnet mask of this interface.
- **Gateway**
Displays the gateway of this interface. This is used for routing packets to remote networks.
- **Primary DNS Server**
Displays the primary DNS server of this interface.
- **Secondary DNS Server**
Displays the secondary DNS server of this interface.

4.2.2 Syslog

Syslog

Syslog Information

```

Aug 17 20:18:24 navigateworx user.err modem[4039]: error in modem c, modem_get_at_cmd_response.riz
Aug 17 20:18:24 navigateworx user.debug connection_manager[6588]: connection_manager proc_disconnected
Aug 17 20:18:24 navigateworx user.debug connection_manager[6588]: cancel timer by disconnected action
Aug 17 20:18:24 navigateworx user.debug connection_manager[6588]: connection of wwan1 is disconnected
Aug 17 20:18:24 navigateworx user.debug connection_manager[6588]: optimal connection wan health state 0 cs 2, current connection wwan1
health state 16 cs 0
Aug 17 20:18:24 navigateworx user.warn connection_manager[6588]: wwan1 is unusable
Aug 17 20:19:52 navigateworx authpriv.info webserver: pam_unix(login:session): session opened for user admin by (uid=0)
Aug 17 20:19:52 navigateworx authpriv.info webserver: pam_unix(login:session): session closed for user admin
Aug 17 20:20:07 navigateworx authpriv.info webserver: pam_unix(login:session): session opened for user admin by (uid=0)
Aug 17 20:20:07 navigateworx authpriv.info webserver: pam_unix(login:session): session closed for user admin
Aug 17 20:20:12 navigateworx authpriv.info webserver: pam_unix(login:session): session opened for user admin by (uid=0)
Aug 17 20:20:12 navigateworx authpriv.info webserver: pam_unix(login:session): session closed for user admin
Aug 17 21:06:02 navigateworx daemon.info dnsmasq-dhcp[5060]: 181367734 available DHCP range: 192.168.5.2 -- 192.168.5.200
Aug 17 21:06:02 navigateworx daemon.info dnsmasq-dhcp[5060]: 181367734 vendor class: MSFT 5.0
Aug 17 21:06:02 navigateworx daemon.info dnsmasq-dhcp[5060]: 181367734 client provides name: Chen
Aug 17 21:06:02 navigateworx daemon.info dnsmasq-dhcp[5060]: 181367734 DHCPREQUEST (lan0) 192.168.5.2 f0:76:1c:5a:4e:cc
Aug 17 21:06:02 navigateworx daemon.info dnsmasq-dhcp[5060]: 181367734 tags: lan0
Aug 17 21:06:02 navigateworx daemon.info dnsmasq-dhcp[5060]: 181367734 DHCPACK (lan0) 192.168.5.2 f0:76:1c:5a:4e:cc Chen
Aug 17 21:06:02 navigateworx daemon.info dnsmasq-dhcp[5060]: 181367734 requested options: 1:netmask, 3:router, 6:dns-server, 15:domain-name,
Aug 17 21:06:02 navigateworx daemon.info dnsmasq-dhcp[5060]: 181367734 requested options: 31:router-discovery, 33:static-route, 43:vendor-
encap,
Aug 17 21:06:02 navigateworx daemon.info dnsmasq-dhcp[5060]: 181367734 requested options: 44:netbios-ns, 46:netbios-nodetype, 47:netbios-
scope,
Aug 17 21:06:02 navigateworx daemon.info dnsmasq-dhcp[5060]: 181367734 requested options: 119:domain-search, 121:classless-static-route,
Aug 17 21:06:02 navigateworx daemon.info dnsmasq-dhcp[5060]: 181367734 requested options: 249, 252
Aug 17 21:06:02 navigateworx daemon.info dnsmasq-dhcp[5060]: 181367734 next server: 192.168.5.1
Aug 17 21:06:02 navigateworx daemon.info dnsmasq-dhcp[5060]: 181367734 sent size: 1 option: 53 message-type 5
Aug 17 21:06:02 navigateworx daemon.info dnsmasq-dhcp[5060]: 181367734 sent size: 4 option: 54 server-identifier 192.168.5.1
Aug 17 21:06:02 navigateworx daemon.info dnsmasq-dhcp[5060]: 181367734 sent size: 4 option: 51 lease-time 2h
Aug 17 21:06:02 navigateworx daemon.info dnsmasq-dhcp[5060]: 181367734 sent size: 4 option: 58 T1 54m43s
Aug 17 21:06:02 navigateworx daemon.info dnsmasq-dhcp[5060]: 181367734 sent size: 4 option: 59 T2 1h39m43s
Aug 17 21:06:02 navigateworx daemon.info dnsmasq-dhcp[5060]: 181367734 sent size: 4 option: 1 netmask 255.255.255.0
Aug 17 21:06:02 navigateworx daemon.info dnsmasq-dhcp[5060]: 181367734 sent size: 4 option: 28 broadcast 192.168.5.255
Aug 17 21:06:02 navigateworx daemon.info dnsmasq-dhcp[5060]: 181367734 sent size: 7 option: 81 PQDN 03:ff:ff:43:68:65:6e
Aug 17 21:06:02 navigateworx daemon.info dnsmasq-dhcp[5060]: 181367734 sent size: 4 option: 6 dns-server 192.168.5.1
Aug 17 21:06:02 navigateworx daemon.info dnsmasq-dhcp[5060]: 181367734 sent size: 4 option: 3 router 192.168.5.1
Aug 17 21:09:57 navigateworx daemon.err udhcpd[6639]: sending renew
Aug 17 21:09:57 navigateworx daemon.err udhcpd[6639]: lease of 192.168.111.33 obtained, lease time 7200
Aug 17 21:09:57 navigateworx user.debug udhcpd: dhcpd update configuration of wan
Aug 17 21:09:57 navigateworx user.debug connection_manager[6588]: connection_manager proc_connected

```

Download Diagnosis
Download Syslog
Clear
Refresh

Syslog Information

- **Download Diagnosis**
Download the Diagnosis file for analysis.
- **Download Syslog**
Download the complete syslog since last reboot.
- **Clear**
Clear the current page syslog printing.
- **Refresh**
Reload the current page with latest syslog printing.

4.3 Link Management





This section shows you the setup of link management.

4.3.1 Connection Manager

Status		Connection			
Connection Information					
Index	Type	Status	IP Address	Netmask	Gateway
1	WWAN1	Disconnected			
2	WAN	Connected	192.168.111.31	255.255.255.0	192.168.111.1

Connection Manager->Status

- Type**
 Displays the connection interface
- Status**
 Displays the connection status of this interface.
- IP Address**
 Displays the IP Address of this interface.
- Netmask**
 Displays the subnet mask of this interface.
- Gateway**
 Displays the gateway of this interface. This is used for routing packets to remote networks.

Status		Connection		
General Settings				
Priority	Enable	Connection Type	Description	
1	true	WWAN1		 
2	true	WAN		 

Click  to add a new priority interface.

Click  to edit current interface settings.

Click  to delete current interface.

Connection Manager->Connection

- **Priority**
Displays the priority list of default routing selection.
- **Enable**
Displays the connection enable status.
- **Connection Type**
Displays the name of this interface.
- **Description**
Displays the description of this connection.

Connection Settings

General Settings

Priority: 3

Enable:

Connection Type: WWAN1

Description:

ICMP Detection Settings

Enable:

Primary Server: 8.8.8.8

Secondary Server: 114.114.114.114

Interval: 300 ?

Retry Interval: 5 ?

Timeout: 3 ?

Retry Times: 3 ?

Save Close

Connection Settings

- **Priority**
Displays current index on priority list.
- **Connection Type**
Select the available interface as outbound link.
NOTE: specify SIM1 carrier link as WWAN1, SIM2 carrier link as WWAN2.
- **ICMP Detection Settings->Enable**
Check this box to detect link connection status based on pings to a specified IP address.
- **Primary Server**
Enter the primary IP address that pings will be sent to, to detect the link state. Recommend entering the IP address of known external reachable server or network (e.g. 8.8.8.8).
- **Secondary Server**
Enter the secondary IP address that pings will be sent to, when the primary server is ping failed, router would try to ping the secondary server.

- **Interval**
The duration of each ICMP detection in seconds.
- **Retry Interval**
The interval in seconds between each ping if no packets have been received.
- **Timeout**
Enter timeout for received ping reply to determine the ICMP detection failure.
- **Retry Times**
Displays the outbound interface of this route.

4.3.2 Cellular

NR500 Router main function is connecting to Internet by cellular modem.

Status		Cellular							
Cellular Information									
Index	Modem	Registration	CSQ	Operator	Netwok Type	IMEI	IMSI	TX Bytes	RX Bytes
1	EC25	Registered	31 (-51dBm)	CHN-UNICOM	LTE	861107038049871	460015956236598	2992	2748
	Index	1							
	Modem	EC25							
	Registration	Registered							
	CSQ	31 (-51dBm)							
	Operator	CHN-UNICOM							
	Netwok Type	LTE							
	IMEI	861107038049871							
	PLMN ID	46001							
	Local Area Code	2508							
	Cell ID	6016C02							
	IMSI	460015956236598							
	TX Bytes	2992							
	RX Bytes	2748							
	Modem Firmware	EC25EFAR06A01M4G							

Copyright © 2018 Guangzhou Navigatowrx Technologies Co., Ltd. All rights reserved.

Cellular->Status

- Modem**
 Displays the model of the modem used by this WWAN interface.
- Registration**
 Displays the registration status of SIM card.
- CSQ**
 Displays the signal strength of the carrier network.
- Operator**
 Displays the wireless network provider.
- Network Type**
 Displays the RF technology currently active. Example: LTE, UMTS, or CDMA.
- IMEI**
 International Mobile Electronic Identifier. Depending on the carrier and technology used, this may be required for the carrier when activating the data contract. In some cases this will be blank.
- PLMN ID**

Displays the current PLMN ID, including MCC, MNC, LAC and Cell ID.

- **Local Area Code**
Displays the location area code of the SIM card.
- **Cell ID**
Displays the Cell ID of the SIM card location.
- **IMSI**
International Mobile Subscriber Identity, as read from the SIM. This is the user's network subscription.
- **TX Bytes**
Displays the total bytes transmitted since the time the unit was connected. NR500 router would record this data with same SIM card, reboot would not erase this data.
- **RX Bytes**
Displays the total bytes received since the time the unit was connected. NR500 router would record this data with same SIM card, reboot would not erase this data.
- **Modem Firmware**
Displays firmware version of the modem used by the WWAN interface.

Status		Cellular	
Modem General Settings			
Index	SIM Card	Auto APN	
1	SIM1	true	<input checked="" type="checkbox"/>
2	SIM2	true	<input checked="" type="checkbox"/>

Cellular

- **SIM Card**
Displays the SIM card support on this unit.
- **Auto APN**
Displays the Enable status of auto APN function.

SIM Card Settings

Modem General Settings

Index	<input type="text" value="1"/>	
SIM Card	<input type="text" value="SIM1"/>	
Auto APN	<input checked="" type="checkbox"/>	
Authentication Type	<input type="text" value="Auto"/>	
PIN Code	<input type="text"/>	?
Monthly Data Limitation	<input type="text" value="0"/>	?
Monthly Billing Day	<input type="text" value="1"/>	?
Override Primary DNS	<input type="text"/>	
Override Secondary DNS	<input type="text"/>	

Modem Network Settings

Network Type	<input type="text" value="Auto"/>	
Use All Bands	<input checked="" type="checkbox"/>	

SIM Card Settings

- **SIM Card**
Displays the current SIM card settings.
- **Auto APN**
Check this box enable auto checking the Access Point Name provided by the carrier.
- **Authentication Type**
Authentication method used by the carrier. Possible selections are Auto, PAP, CHAP.
- **PIN Code**
Enter a 4-8 characters PIN code to unlock the SIM.
- **Monthly Data Limitation**
Enter the data total amount for SIM card, SIM card switchover when data reach limitation.
- **Monthly Billing Day**
Enter the date of renew data amount every month.
- **Override Primary DNS**
Enter the primary DNS server will override the automatically obtained DNS.
- **Override Secondary DNS**
Enter the secondary DNS server will override the automatically obtained DNS.
- **Network Type**
Select the mode of operation of the cell module (Auto, 4G Firstly, 4G Only, etc.).
- **Use All Bands**
Check this box to enable all bands selection or choose specified bands.

4.3.3 Ethernet

The same instructions apply to settings for all Ethernet interfaces.

Status	Port Assignment	WAN	LAN	
Ethernet Port Information				
Index	Name	Status		
1	ETH0	Up		
2	ETH1	Up		
3	ETH2	Down		
4	ETH3	Down		
Interface Information				
Index	Name	MAC Address		
1	wan			
2	lan0	A8:3F:A1:E0:BD:49		
DHCP Lease Table				
Index	MAC Address	IP Address	Lease Expires	Hostname
1	98:10:e8:67:dd:35	192.168.111.10	2018-10-18 12:11:13	iPhone

Ethernet->Status

- Ethernet Port Information**
 Displays the port physical connected states.
- Interface Information**
 Displays the name and MAC address of Ethernet interface.
- DHCP Lease Table**
 Displays the current IP address assigned to DHCP client.

Ethernet->Port Assignment

- Port**
 Displays the port states and numbers of this unit.
- Interface**
 Displays the port states of belong subnet.

Port Settings

General Settings

Index

Port

Interface

Ethernet->Port Settings

- **Port**
Indicate the current configurate port.
- **Interface**
Select belong subnet for current configurate port.

Status	Port Assignment	<u>WAN</u>	LAN
General Settings			
		Connection Type	DHCP
Advanced Settings			
		NAT Enable	<input checked="" type="checkbox"/>
		MTU	1500
		Override Primary DNS	
		Override Secondary DNS	

Ethernet->WAN

- **Connection Type**
If you select DHCP Client, external DHCP server will assign an IP address to this unit.
- **NAT Enable**
Enable or Disable NAT (Network Address Translation).
- **MTU**
Maximum Transmission Unit, maximum packet size allowed to be transmitted. Should be left as default value of 1500 in most cases.
- **Override Primary DNS**
Enter the primary DNS server will override the automatically obtained DNS.
- **Override Secondary DNS**
Enter the secondary DNS server will override the automatically obtained DNS.

NR500 also support WAN connection type set to Static IP and PPPoE mode.

Status	Port Assignment	<u>WAN</u>	LAN
General Settings			
		Connection Type	Static IP
		IP Address	
		Netmask	
		Gateway	
		Primary DNS	
		Secondary DNS	

Status	Port Assignment	<u>WAN</u>	LAN
General Settings			
	Connection Type	PPPoE ▼	
	Authentication Type	Auto ▼	
	Username	<input type="text"/>	
	Password	<input type="text"/>	

Ethernet->WAN->Static IP or PPPoE

- **IP Address**
Static address for this interface. It must be on the same subnet as the gateway.
- **Netmask**
Will be assigned by the gateway.
- **Gateway**
IP address of the Gateway (DHCP Host). If not known this can be left as all zeros.
- **Primary DNS**
IP address of the primary DNS server.
- **Secondary DNS**
IP address of the secondary DNS server.
- **Authentication Type**
Authentication method used by the carrier. Possible selections are Auto, PAP, CHAP.
- **Username**
Username to provide when connecting.
- **Password**
Password to provide when connecting.

Status	Port Assignment	WAN	<u>LAN</u>
General Settings			
Index	Interface	IP Address	Netmask
1	LAN0	192.168.111.1	255.255.255.0
Multiple IP Settings			
Index	Interface	IP Address	Netmask

Ethernet->LAN

- **Interface**
Displays current name of LAN subnet.
- **IP Address**
Displays LAN IP address of this subnet.
- **Netmask**
Displays subnet mask for this subnet.

LAN Settings	
General Settings	
Index	<input type="text" value="1"/>
Interface	<input type="text" value="LAN0"/>
IP Address	<input type="text" value="192.168.5.1"/>
Netmask	<input type="text" value="255.255.255.0"/>
MTU	<input type="text" value="1500"/>
DHCP Settings	
Enable	<input checked="" type="checkbox"/>
Mode	<input type="text" value="Server"/>
IP Pool Start	<input type="text" value="192.168.5.2"/>
IP Pool End	<input type="text" value="192.168.5.200"/>
Netmask	<input type="text" value="255.255.255.0"/>
Lease Time	<input type="text" value="120"/>
Gateway	<input type="text"/>
Primary DNS	<input type="text"/>
Secondary DNS	<input type="text"/>
WINS Server	<input type="text"/>
<input type="button" value="Save"/> <input type="button" value="Close"/>	
DHCP Settings	
Enable	<input checked="" type="checkbox"/>
Mode	<input type="text" value="Relay"/>
Relay Server	<input type="text"/>
<input type="button" value="Save"/> <input type="button" value="Close"/>	

Ethernet->LAN

- **Interface**
Select the configure LAN port of this subnet.
- **IP Address**
Enter LAN IP address for this interface.
- **Netmask**
Enter subnet mask for this subnet.
- **MTU**
Maximum Transmission Unit, maximum packet size allowed to be transmitted. Should be left as default value of 1500 in most cases.
- **Enable**
Check this box to enable DHCP feature on current LAN port.
- **Mode**
Select the DHCP working mode from "Server" or "Relay".

- **Relay Server**
Enter the IP address of DHCP relay server.
- **IP Pool Start**
External LAN devices connected to this unit will be assigned IP address in this range when DHCP is enabled. This is the beginning of the pool of IP addresses.
- **IP Pool End**
This is the end of the pool of IP addresses.
- **Netmask**
Subnet mask of the IP address obtained by DHCP clients from DHCP server.
- **Lease Time**
The lease time of the IP address obtained by DHCP clients from DHCP server.
- **Gateway**
The gateway address obtained by DHCP clients from DHCP server.
- **Primary DNS**
Primary DNS server address obtained by DHCP clients from DHCP server.
- **Secondary DNS**
Secondary DNS server address obtained by DHCP clients from DHCP server.
- **WINS Server**
Windows Internet Naming Service obtained by DHCP clients from DHCP server.

Multiple IP Settings	
General Settings	
Index	<input type="text" value="1"/>
Interface	<input type="text" value="LAN0"/>
IP Address	<input type="text"/>
Netmask	<input type="text"/>
<input type="button" value="Save"/> <input type="button" value="Close"/>	

Ethernet->LAN->Multiple IP Settings

- **Interface**
Select the configurate LAN port of this subnet.
- **IP Address**
Enter multiple IP address for this interface.
- **Netmask**
Enter subnet mask for this subnet.

4.3.4 Wi-Fi

NR500 router could only be set to function as either a Wi-Fi Client or a Wi-Fi Access Point, but not both simultaneously. Select Wi-Fi (Access Point) from the main navigation menu to Wi-Fi (default as Access Point) page, which contains tabs for configuration of the Wi-Fi Access Point interface.

You could review the Wi-Fi connection status as below.

<u>Status</u>	Basic	WiFi AP	
WiFi Status			
Status	Ready		
SSID	NR500-WAN		
MAC Address	a8:3f:a1:e0:ab:81		
Current Channel	6		
Channel Width	40 MHz		
TX Power	20.00 dBm		
Associated Station			
Index	MAC Address	Signal	Station Name
1	30:59:b7:16:3b:66	-55 dBm	KEN-COMPUTER
2	98:10:e8:67:dd:35	-64 dBm	iPhone

<u>Status</u>	<u>Basic</u>	WiFi AP
Basic Settings		
Running Mode	<input type="text" value="AP"/>	
Country Code	<input type="text" value="CN"/>	

Wi-Fi->Basic

- **Running Mode**
Select the configurate Wi-Fi mode from AP or Client.
- **Country Code**
Enter the country where the AP is located.

Wi-Fi AP

Wi-Fi AP settings page as below.

Status	Basic	WiFi AP
WiFi AP Settings		
Enable	<input checked="" type="checkbox"/>	
SSID	<input type="text" value="wifi-a-p"/>	
Enable Broadcast SSID	<input type="checkbox"/>	
Security Mode	<input type="text" value="WPA PSK"/>	
WPA Type	<input type="text" value="Auto"/>	
Encryption Type	<input type="text" value="Auto"/>	
Password	<input type="text"/>	<input style="font-size: small; vertical-align: middle;" type="text" value="?"/>
Advanced Settings		
Channel	<input type="text" value="Auto"/>	
Wireless Mode	<input type="text" value="802.11bgn"/>	
Channel Width	<input type="text" value="40 MHz"/>	
Beacon TX Rate HT MCS Index	<input type="text" value="Auto"/>	<input style="font-size: small; vertical-align: middle;" type="text" value="?"/>
TX Power	<input type="text" value="High"/>	
Beacon Interval	<input type="text" value="100"/>	
DTIM Period	<input type="text" value="100"/>	
Max Client Support	<input type="text" value="64"/>	
Enable Short GI	<input checked="" type="checkbox"/>	
Enable AP Isolate	<input type="checkbox"/>	

Wi-Fi->Wi-Fi AP

- **Enable**
Check this box will enable the Wireless interface.
- **SSID**
The SSID is the name of the wireless local network. Devices connecting to the Nr500 router WiFi access will identify the Access Point by this SSID.
- **Enable Broadcast SSID**
When the checkbox is not checked, SSID broadcast is disabled, other wireless devices can't not find the SSID, and users have to enter the SSID manually to access to the wireless network.
- **Security Mode**
Select security mode from "None" or "WPA PSK".
- **WPA Type**
Select WPA Type from "Auto", "WPA" and "WPA2".
- **Encryption Type**
Select the encryption method. Options are "Auto", "TKIP", or "CCMP". Because these options depend on the authentication method selected, some options will not be available.
- **Password**
Enter the pre-shared key of WPA encryption.

- **Channel**
Select the Wi-Fi channel the module will transmit on. If there are other Wi-Fi devices in the area the NR500 router should be set to a different channel than the other access points. Channels available for selection depend on the selected Band.
- **Wireless Mode**
Select the Wi-Fi 802.11 mode: B, G, or N. Available selections depend on selected Band.
- **Channel Width**
Select the width of the Wi-Fi channel. 20 MHz will limit the channel to 20 MHz wide; 20/40 MHz will enable the use of a 40 MHz wide channel when available.
- **Beacon TX Rate HT MCS Index**
Modulation and Coding Scheme, The MCS modulation coding table is a representation proposed by 802.11n to characterize the communication rate of the WLAN. The MCS takes the factors affecting the communication rate as the columns of the table and uses the MCS index as a row to form a rate table.
- **TX power**
Select the transmission power for the AP from "High", "Medium" and "Low".
- **Beacon Interval**
Enter the interval of time in which the router AP broadcasts a beacon which is used for wireless network authentication.
- **DTIM Period**
Enter the delivery traffic indication message period and the router AP will multicast the data according to this period.
- **Max Client Support**
Enter the maximum number of clients to access when the router is configured as AP.
- **Enable Short GI**
Check this box to enable Short GI(guard interval), Short GI is a blank time between two symbols, providing a long buffer time for signal delay.
- **Enable AP Isolate**
Check this box to enable AP isolate, the route will isolate all connected wireless devices.

Wi-Fi Client

Wi-Fi Client settings page as below.

Status	Basic	<u>WiFi Client</u>
WiFi Client Settings		
Enable	<input checked="" type="checkbox"/>	
Connect to Hidden SSID	<input type="checkbox"/>	
SSID	<input type="text"/>	
Password	<input type="text"/>	
IP Address Settings		
Connection Type	<input type="text" value="DHCP"/>	

Status	Basic	<u>WiFi Client</u>
WiFi Client Settings		
Enable	<input checked="" type="checkbox"/>	
Connect to Hidden SSID	<input type="checkbox"/>	
SSID	<input type="text"/>	
Password	<input type="text"/>	
IP Address Settings		
Connection Type	<input type="text" value="Static IP"/>	
IP Address	<input type="text"/>	
Netmask	<input type="text"/>	
Gateway	<input type="text"/>	
Primary DNS	<input type="text"/>	
Secondary DNS	<input type="text"/>	

Wi-Fi->Wi-Fi Client

- **Enable**
Check this box will enable the Wireless interface.
- **Connect to Hidden SSID**
Check this box will enable connect to hidden SSID.
- **SSID**
The SSID of external access point.
- **Password**
Enter the primary DNS server will override the automatically obtained DNS.
- **Connection Type**
Select from DHCP Client or Static IP address.
- **IP Address**
Static address for this interface. It must be on the same subnet as the gateway.
- **Netmask**
Will be assigned by the gateway.
- **Gateway**
IP address of the Gateway.
- **Primary DNS**
Enter the primary DNS server will override the automatically obtained DNS.
- **Secondary DNS**
Enter the secondary DNS server will override the automatically obtained DNS.

4.4 Industrial Interface

The Industrial page contains tabs for making configuration settings for Serial RS232 and RS485, Digital input and output. Select Serial & Digital IO from the main navigation menu to navigate to this page.

4.4.1 Serial

You could review the status of serial connection.

<u>Status</u>		Connection			
Serial Information					
Index	Enable	Serial Type	Transmission Method	Protocol	Connection Status
1	false	RS485	Transparent	TCP Client	Disconnected
2	false	RS232	Transparent	TCP Client	Disconnected

Serial->Status

- **Enable**
Displays status of current serial function.
- **Serial Type**
Displays the serial type of COM port.
- **Transmission Method**
Displays the transmission method of this serial port.
- **Protocol**
Displays the protocol used by this serial port.
- **Connection Status**
Displays the connection status of this serial port.

Status		Connection				
Serial Connection Settings						
Index	Enable	Port	Baud Rate	Data Bits	Stop Bits	Parity
1	false	COM1	115200	8	1	None
2	false	COM2	115200	8	1	None

Serial->Connection

- **Enable**
Displays status of current serial function.
- **Port**
Displays the serial type of COM port.
- **Baud Rate**
Displays the serial port baud rate.
- **Data Bits**
Displays the serial port Data Bits.
- **Stop Bits**
Displays the serial port Stop Bits.
- **Parity**
Displays the serial port parity.

Connection Settings

Serial Connection Settings

Index:

Enable:

Port:

Baud Rate:

Data Bits:

Stop Bits:

Parity:

Transmission Settings

Transmission Method:

MTU: ?

Protocol:

Remote IP Address:

Remote Port:

Serial->Connection Settings

- **Baud Rate**
Select the serial port baud rate. Supported values are 2400, 4800, 9600, 19200, 38400, 57600, or 115200.
- **Data Bits**
Select the values from 5, 6, 7 or 8.
- **Stop Bits**
Select the values from 1 or 2.
- **Parity**
Select values from none, even, odd.
- **Transmission Method**
Select the transmission method for serial port.
- **MTU**
Maximum Transmission Unit, maximum packet size allowed to be transmitted. Should be left as default value of 1024 in most cases.
- **Protocol**
Select the mode for Serial IP communication. Supported modes are UDP, TCP Server, or TCP Client.
- **Remote IP Address**
Enter the IP address of the remote server.
- **Remote Port**
Enter the port number of the remote server.

Below window displays different settings when you select **TCP Server** on Protocol.

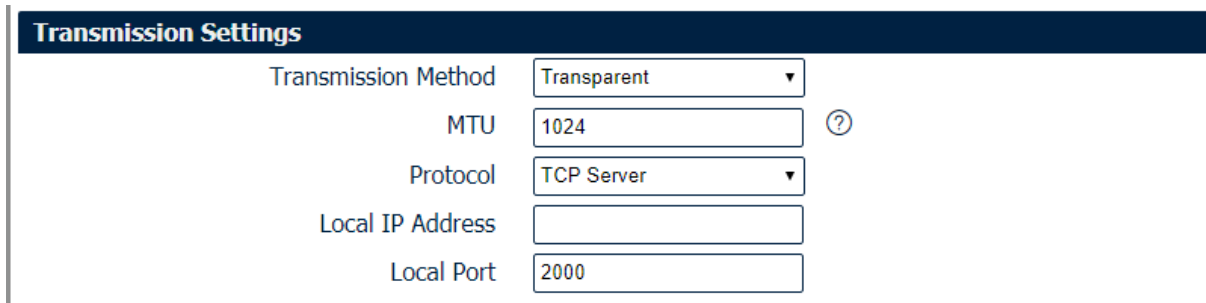

The screenshot shows a window titled "Transmission Settings" with the following fields:

Transmission Method	Transparent
MTU	1024
Protocol	TCP Server
Local IP Address	
Local Port	2000

Serial->Connection Settings

- **Local IP Address**
Enter the IP Address of the local endpoint.
- **Local Port**
The port number assigned to the serial IP port on which communications will take place.

Below window displays different settings when you select **UDP** on Protocol.

Transmission Settings	
Transmission Method	Transparent ▼
MTU	1024 ⓘ
Protocol	UDP ▼
Local IP Address	<input type="text"/>
Local Port	2000
Remote IP Address	<input type="text"/>
Remote Port	2000

Serial->Connection Settings

- **Local IP Address**
Enter the IP Address of the local endpoint.
- **Local Port**
The port number assigned to the serial IP port on which communications will take place.
- **Remote IP Address**
Enter the IP address of the remote server.
- **Remote Port**
Enter the port number of the remote server.

4.4.2 Digital IO

This section allows you to set the Digital IO parameters. The Digital input could be used for triggering alarm, and Digital output could be used for controlling the slave device by digital signal.

You could review the status of Digital IO as below.

Status		Digital IO	
Digital Input Information			
Index	Enable	Logic Level	Status
1	false	High	Alarm OFF
2	false	High	Alarm OFF
Digital Output Information			
Index	Enable	Logic Level	Status
1	false	Low	Alarm OFF
2	false	Low	Alarm OFF

Digital IO->Status

- **Enable**
Displays status of current digital IO function.
- **Logic Level**
Displays the electrical level of digital IO port.
- **Status**
Displays the alarm status of digital IO port.

Digital Input

Digital Input Settings

Index

Enable

Alarm ON Mode

Digital IO->Digital Input

- **Enable**
Check this box to enable digital Input function.
- **Alarm ON Mode**
Select the electrical level to trigger alarm. Option are "Low" and "High".

Digital Output

Digital Output Settings

Index	<input type="text" value="1"/>
Enable	<input type="checkbox"/>
Alarm Source	<input type="text" value="Digital Input 1"/>
Alarm ON Action	<input type="text" value="High"/>
Alarm OFF Action	<input type="text" value="Low"/>

Digital IO->Digital Output

- **Enable**
Check this box to enable digital output function.
- **Alarm Source**
Select from "Digital Input1" or "Digital Input2", Digital output triggers the related action when there is alarm comes from Digital Input.
- **Alarm ON Action**
Select from "High", "Low" or "Pulse". High means high electrical level output. Low means low electrical level output. Pulse will generate a square wave as specified in the pulse mode parameters when triggered.
- **Alarm OFF Action**
Initiates when alarm disappeared. Select from "High", "Low" or "Pulse". High means high electrical level output. Low means low electrical level output. Pulse will generate a square wave as specified in the pulse mode parameters when triggered.
- **Pulse Width**
This parameter is available when select "Pulse" as "Alarm ON Action/Alarm OFF Action". The selected digital output channel will generate a square wave as specified in the pulse mode parameters.

4.5 Network

4.5.1 Firewall

Firewall rules are security rule-sets to implement control over users, applications or network objects in an organization. Using the firewall rule, you can create blanket or specialized traffic transit rules based on the requirement.

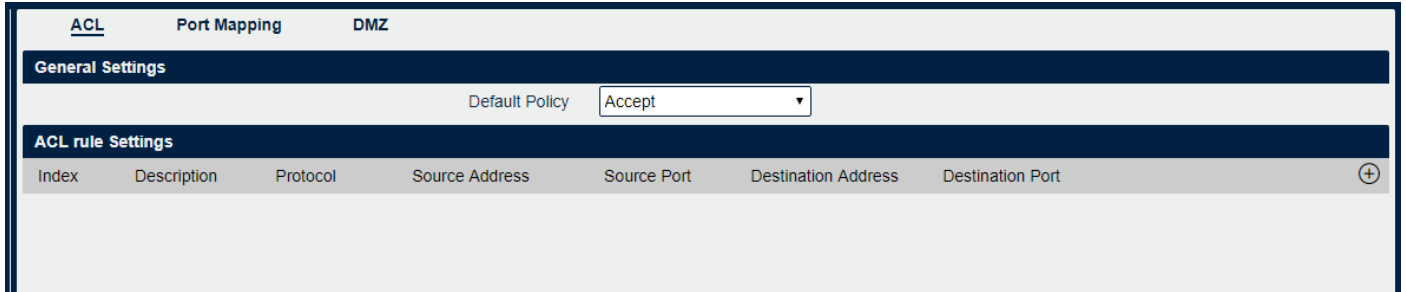

Firewall->ACL

- **Default Policy**

Select the "Accept" or "Drop" from the list, the packets which are not included in the access control list will be processed by the default filter policy.

An access control list (ACL), with respect to a computer file system, is a list of permissions attached to an object. An ACL specifies which users or system processes are granted access to objects, as well as what operations are allowed on given objects.

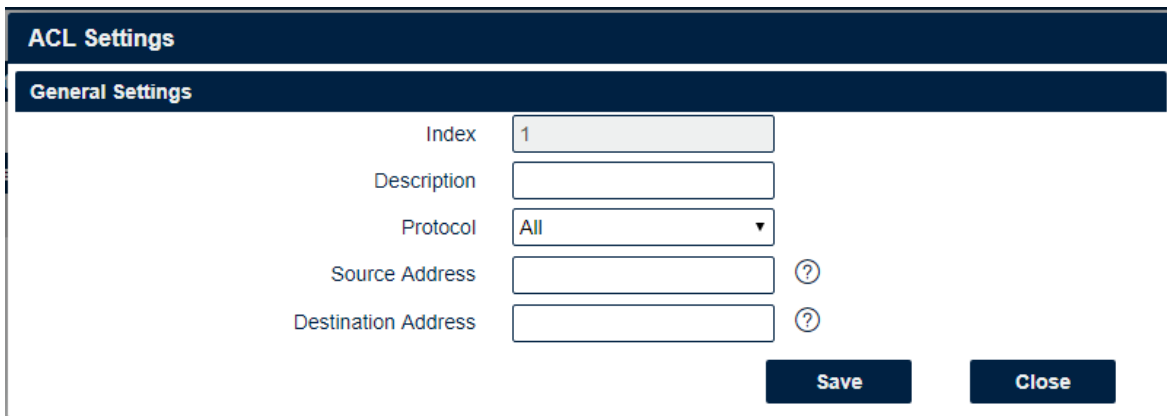

Firewall->ACL

- **Description**
Add a description for this rule.
- **Protocol**
Any: Any protocol number.
TCP: The TCP protocol.
UDP: The UDP protocol.
TCP & DUP: both TCP and UDP protocol
ICMP: The ICMP protocol.
- **Source Address**
A specific host IP address can also be specified, or a range of IP addresses via a bitmask (the box following the /).
- **Destination Address**
A specific IP address can also be specified, or a range of IP addresses via a bitmask (the box following the /).

Port Mapping Settings	
Port Mapping rule Settings	
Index	<input type="text" value="1"/>
Description	<input type="text"/>
Protocol	<input type="text" value="All"/> ?
Remote Address	<input type="text"/> ?
Remote Port	<input type="text"/> ?
Local Address	<input type="text"/> ?
Local Port	<input type="text"/> ?

Firewall->Port Mapping

- **Description**
Add a description for this rule.
- **Protocol**
Any: Any protocol number.
TCP: The TCP protocol.
UDP: The UDP protocol.
- **Remote Address**
Enter a WAN IP address that is allowed to access the unit.
- **Remote Port**
Enter the external port number range for incoming requests.
- **Local Address**
Sets the LAN address of a device connected to one of the Fusion's LAN interfaces. Inbound requests will be forwarded to this IP address.

- Local Port**
 Sets the LAN port number range used when forwarding to the destination IP address.

ACL
Port Mapping
DMZ

General Settings

Enable

Remote Address

?

DMZ Host Address

Firewall->DMZ

- Enable**
 Check this box to enable DMZ function.
- Remote Address**
 Optionally restricts DMZ access to only the specified WAN IP address.
NOTE: If set to 0.0.0.0, the DMZ is open to all incoming WAN IP addresses.
- DMZ Host Address**
 The WAN IP address which has all ports exposed except ports defined in the Port Forwarding configuration.

4.5.2 Route

Static Routing refers to a manual method of setting up routing between networks. Select the Static Routing tab to add static routes to the Static Route Table.

Please refer current route table as below.

Status	Route			
Route Table Information				
Index	Destination	Netmask	Gateway	Interface
1	0.0.0.0	0.0.0.0	192.168.129.1	wan
2	192.168.111.0	255.255.255.0	0.0.0.0	lan0
3	192.168.129.0	255.255.255.0	0.0.0.0	wan

Route->Route Table Information

- Destination**
 Displays the destination of routing traffic.
- Netmask**
 Displays the subnet mask of this routing.
- Gateway**

Displays the gateway of this interface. This is used for routing packets to remote networks.

- **Interface**
Displays the outbound interface of this route.

Static Route Settings

Route Table Information

Index	<input style="width: 60%;" type="text" value="1"/>
Description	<input style="width: 60%;" type="text"/>
IP Address	<input style="width: 60%;" type="text"/>
Netmask	<input style="width: 60%;" type="text"/>
Gateway	<input style="width: 60%;" type="text"/>
Interface	<input style="width: 60%;" type="text"/> ?

Route->Static Route Settings

- **Description**
Enter the description of current static route rule.
- **IP Address**
Enter the IP address of the destination network.
- **Netmask**
Enter the subnet mask of the destination network.
- **Gateway**
Enter the IP address of the local gateway.
- **Interface**
Please refer to the Network->Route->Status interface.

4.5.3 VRRP

The Virtual Router Redundancy Protocol (VRRP) is a computer networking protocol that provides automatic assignment of available Internet Protocol (IP) routers for participating hosts. The VRRP router who has the highest number will become the virtual master router. The VRRP router number ranges from 1 to 255 and usually we use 255 for the highest priority and 100 for backup. If the current virtual master router receives an announcement from a group member (Router ID) with a higher priority, then the latter will pre-empt and become the virtual master router.

VRRP

VRRP Network Settings

Index	<input type="text" value="1"/>
Enable	<input checked="" type="checkbox"/>
Interface	<input type="text" value="LAN0"/>
Virtual Router ID	<input type="text" value="1"/>
Authentication Type	<input type="text" value="None"/> ?
Priority	<input type="text" value="100"/>
Interval	<input type="text" value="1"/>
Virtual IP Address	<input type="text"/>

Network->VRRP

- **Enable**
Check this box will enable VRRP.
- **Interface**
Select the interface of Virtual Router.
- **Virtual Router ID**
User-defined Virtual Router ID. Range: 1-255.
- **Authentication Type**
Select the authentication type for VRRP.
- **Priority**
Enter the VRRP priority range is 1-254 (a bigger number indicates a higher priority).
- **Interval**
Heartbeat package transmission time interval between routers in the virtual IP group. Range: 1-255.
- **Virtual IP Address**
Enter the virtual IP address of virtual gateway.

4.6 Applications

4.6.1 DDNS

DDNS is a system that allows the domain name data of a computer with a varying (dynamic) IP addresses held in a name server to be updated in real time in order to make it possible to establish connections to that machine without the need to track the actual IP addresses at all times. A number of providers offer Dynamic DNS services (DDNS), free or for a charge.

You could review the status of DDNS as below.

Status	DDNS
DDNS Status	
Status	Updating
Public IP Address	
Status	DDNS
General Settings	
Enable	<input type="checkbox"/>
DDNS Provider	no-ip ▼
Check IP Interval	<input type="text"/> ⓘ
Enable SSL	<input type="checkbox"/>
Username	<input type="text"/>
Password	<input type="text"/>
Hostname	<input type="text"/>
Log Level	None ▼

DDNS

- **Enable**
Check this box to enable the DDNS service.
- **DDNS Provider**
Select the DDNS provider from the list, options from “DynDNS”, “no-ip”, “3322” and custom.
- **Check IP Interval**
Enter the interval, in minutes (0 to 65,535), the modem will update the Dynamic DNS server of its carrier assigned IP address.
- **DDNS Server**
The internet address to communicate the Dynamic DNS information to. This option is available after you select **custom** on DDNS Provider.
- **DDNS Path**
DDNS path for custom type.
- **Check IP Server**
Check IP Server for custom type

- **Check IP Path**
Check IP Path for custom type.
- **Enable SSL**
Enable SSL for connection.
- **Username**
Enter the user name used when setting up the account. Used to login to the Dynamic DNS service.
- **Password**
Enter the password associated with the account.
- **Hostname**
Enter the hostname associated with the account.
- **Log Level**
Select the log output level from "none", "Debug", "Notice", "Info" and "Error".

4.6.2 Schedule Reboot

Schedule reboot allows user to define the time for router reboot itself.

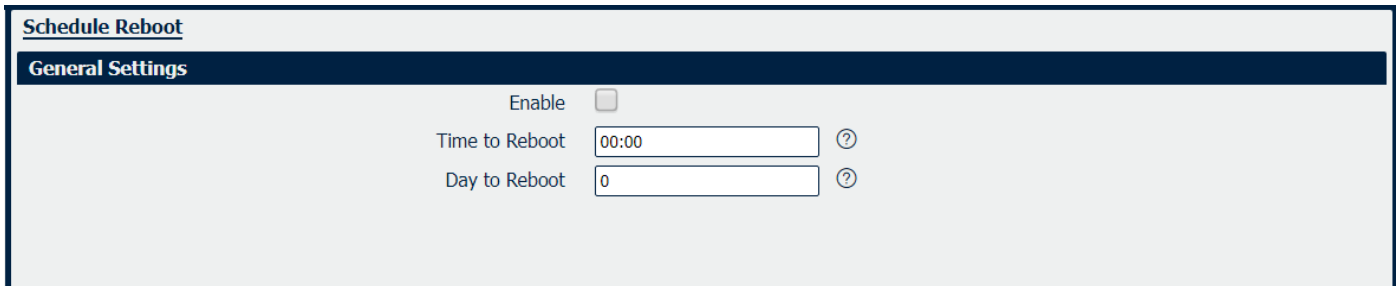

Schedule Reboot

General Settings

Enable

Time to Reboot ?

Day to Reboot ?

Application->Schedule Reboot

- **Enable**
Check this box to enable schedule reboot feature.
- **Time to Reboot**
Enter the time of each day to reboot device. Format: HH(00-23):MM(00-59).
- **Uptime**
Enter the day of each month to reboot device. 0 means every day.

4.7 VPN

4.7.1 OpenVPN

OpenVPN is an open source virtual private network (VPN) product that offers a simplified security framework, modular network design, and cross-platform portability.

You could review all OpenVPN connection as below.



OpenVPN Information					
Index	Enable	Description	Status	Uptime	Virtual IP

VPN->OpenVPN->Status

- **Enable**
Displays current OpenVPN settings is enable or disable.
- **Status**
Displays the current VPN connection status.
- **Uptime**
Displays the connection time since VPN is established.
- **Virtual IP**
Displays the virtual IP address obtain from remote side.

OpenVPN Settings

General Settings

Index	<input type="text" value="1"/>
Enable	<input checked="" type="checkbox"/>
Description	<input type="text"/>
Mode	<input type="text" value="Client"/>
Protocol	<input type="text" value="UDP"/>
Connection Type	<input type="text" value="TUN"/>
Server Address	<input type="text"/>
Server Port	<input type="text" value="1194"/>
Authentication Method	<input type="text" value="X.509"/> ?
Encryption Type	<input type="text" value="BF-CBC"/>
Renegotiate Interval	<input type="text" value="3600"/>
Keepalive Interval	<input type="text" value="20"/>
Keepalive Timeout	<input type="text" value="60"/>
Fragment	<input type="text" value="0"/> ?
Private Key Password	<input type="text"/>
Output Verbosity Level	<input type="text" value="3"/>

Advanced Settings

Enable NAT

VPN->OpenVPN

- **Enable**
Check this box to enable OpenVPN tunnel.
- **Description**
Enter a description for this OpenVPN tunnel.
- **Mode**
Select from "Client" or "P2P".
- **Protocol**
Select from "UDP" or "TCP Client".
- **Connection Type**
Select from "TUN", "TAP" which are two different kinds of device interface for OpenVPN. The difference between TUN and TAP device is that a TUN device is a point-to-point virtual device on network while a TAP device is a virtual device on Ethernet.
- **Server Address**
Enter the IP address or domain of remote server.
- **Server Port**
Enter the negotiate port on OpenVPN server.

- **Authentication Method**
Select from "X.509", "Pre-shared", "Password", and "X.509 And Password".
- **Encryption Type**
Select from "BF-CBC", "DE-CBC", "DES-EDE3-CBC", "AES-128-CBC", "AES-192-CBC" and "AES-256-CBC".
- **Username**
Enter the username for authentication when selection from "Password" or "X.509 And Password".
- **Password**
Enter the password for authentication when selection from "Password" or "X.509 And Password".
- **Local IP Address**
Enter the local virtual IP address when select "P2P" mode.
- **Remote IP Address**
Enter the remote virtual IP address when select "P2P" mode.
- **Local Netmask**
Enter the local netmask when select "TAP" connection type.
- **TAP Bridge**
Select the specified LAN that bridge with OpenVPN tunnel when select "TAP" connection type.
- **Renegotiate Interval**
Enter the renegotiate interval if connection is failed.
- **Keepalive Interval**
Enter the keepalive interval to check the tunnel is active or not.
- **Keepalive Timeout**
Enter the keepalive timeout, once connection is failed it will trigger the OpenVPN reconnect.
- **Fragment**
Enter the fragment size, 0 means disable.
- **Private Key Password**
Enter the private key password for authentication when selection from "X.509" or "X.509 And Password".
- **Output Verbosity Level**
Enter the level of the output log and values.

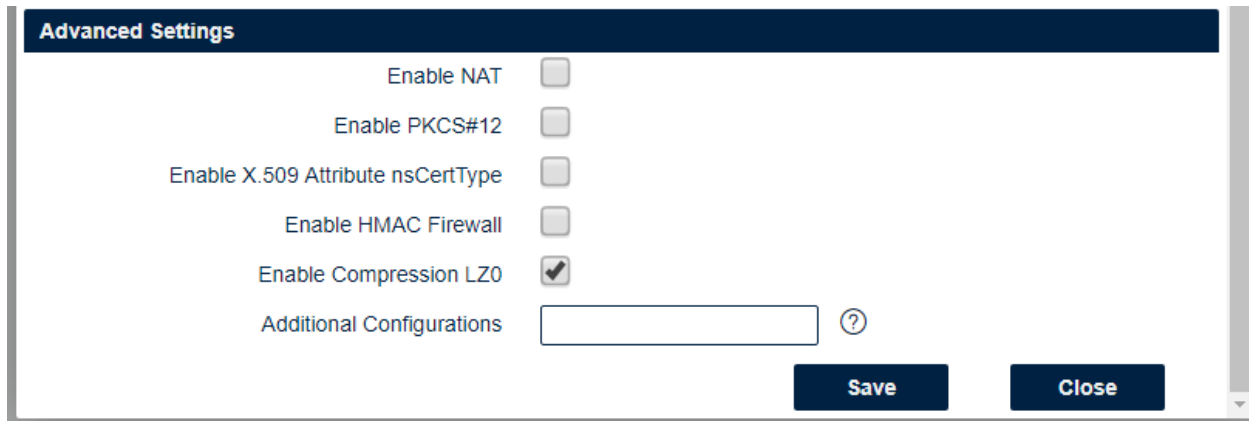

VPN->OpenVPN->Advanced Settings

- Enable NAT**
 Check this box to enable NAT, the source IP of host behind router will be disguised before accessing the remote end.
- Enable PKCS#12**
 It is an exchange of digital certificate encryption standard, used to describe personal identity information.
- Enable X.509 Attribute nsCertType**
 Require that peer certificate was signed with an explicit nsCertType designation of "server".
- Enable HMAC Firewall**
 Add additional layer of HMAC authentication on the top of the TLS control channel to protect against DoS attacks.
- Enable Compression LZ0**
 Compress the data.
- Additional Configurations**
 Enter some other options of OpenVPN in this field. Each expression can be separated by a ';'.

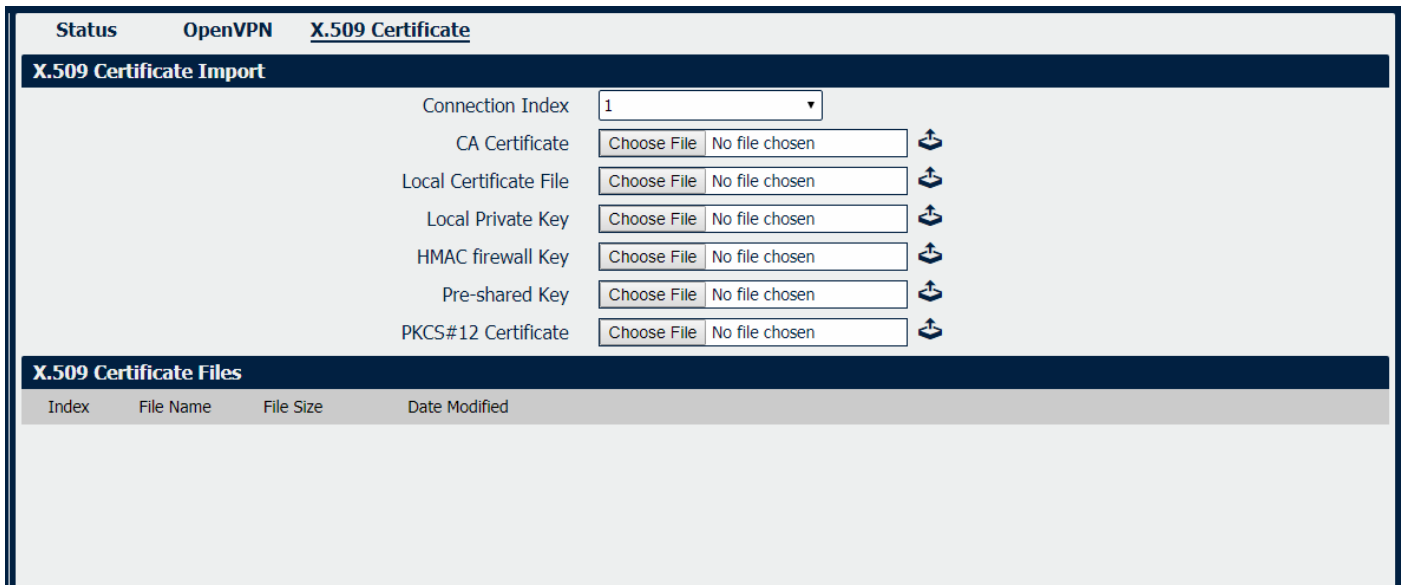

VPN->OpenVPN->X.509 Certificate

- **Connection Index**
Displays the current connection index for OpenVPN channel.
- **CA Certificate**
Import CA certificate file.
- **Local Certificate File**
Import Local Certificate file.
- **Local Private Key**
Import Local Private Key file.
- **HMAC Firewall Key**
Import HMAC Firewall Key file.
- **Pre-shared Key**
Import the pre-shared key file.
- **PKCS#12 Certificate**
Import PKCS#12 Certificate

4.7.2 IPsec

IPsec facilitates configuration of secured communication tunnels. The various tunnel configurations will be displayed in the Tunnel Table at the bottom of the page. All tunnels are create using the ESP (Encapsulating Security Payload) protocol.

Status		IPSec		
IPSec Information				
Index	Enable	Description	Status	Uptime

VPN->IPSec->Status

- Enable**
 Displays current IPsec settings is enable or disable.
- Description**
 Displays the description of current VPN channel.
- Status**
 Displays the current VPN connection status.
- Uptime**
 Displays the connection time since VPN is established.

IPsec Settings

General Settings

Index	<input type="text" value="1"/>
Enable	<input checked="" type="checkbox"/>
Description	<input type="text"/>
Remote Gateway	<input type="text"/>
IKE Version	<input type="text" value="IKEv1"/>
Connection Type	<input type="text" value="Tunnel"/>
Negotiation Mode	<input type="text" value="Main"/>
Authentication Method	<input type="text" value="Pre-shared Key and Xauth"/>
Local Subnet	<input type="text"/>
Local Pre-shared Key	<input type="text"/>
Local ID Type	<input type="text" value="IPv4 Address"/>
Xauth Identity	<input type="text"/>
Xauth Password	<input type="text"/>
Remote Subnet	<input type="text"/>
Remote ID Type	<input type="text" value="IPv4 Address"/>

VPN->IPSec

- **Enable**
Select Enable will launch the IPSec process.
- **Description**
Enter a description for this IPSec VPN tunnel.
- **Remote Gateway**
Enter the IP address of the remote endpoint of the tunnel.
- **IKE Version**
Internet Key Exchange, select from "IKEv1" or "IKEv2".
- **Connection Type**
Select from "Tunnel" or "Transport".
Tunnel: In tunnel mode, the entire IP packet is encrypted and authenticated. It is then encapsulated into a new IP packet with a new IP header. Tunnel mode is used to create virtual private networks for network-to-network communications.
Transport: In transport mode, only the payload of the IP packet is usually encrypted or authenticated. The routing is intact, since the IP header is neither modified nor encrypted.
- **Negotiation Mode**
Select from "Main" or "Aggressive".
- **Authentication Method**
Select from "Pre-shared Key" or "Pre-shared Key and Xauth".
- **Local Subnet**
Enter the IP address with mask if a network beyond the local LAN will be sending packets through the tunnel.
NOTE: The Remote subnet and Local subnet addresses must not overlap!
- **Local Pre-shared Key**
Enter the pre-shared key which match the remote endpoint.
- **Local ID Type**
The local endpoint's identification. The identifier can be a host name or an IP address.
- **Xauth Identity**
Enter Xauth identity after "Pre-shared Key and Xauth" on authentication Method is enabled.
- **Xauth Password**
Enter Xauth password "Pre-shared Key and Xauth" on authentication Method is enabled.
- **Remote Subnet**
Enter an IP address with mask if encrypted packets are also destined for the specified network that is beyond the Remote IP Address.
NOTE: The Remote subnet and Local subnet addresses must not overlap!
- **Remote ID Type**
The authentication address of the remote endpoint.

IKE Proposal Settings	
Encryption algorithm	AES-256 ▼
Hash Algorithm	SHA2 256 ▼
Diffie-Hellman group	Group5(modp1536) ▼
Lifetime	1440
ESP Proposal Settings	
Encryption algorithm	AES-256 ▼
Hash Algorithm	SHA2 256 ▼
Diffie-Hellman group	Group5(modp1536) ▼
Lifetime	60
Advanced Settings	
DPD Interval	30 ?
DPD Timeout	90 ?
Additional Configurations	? <input type="text"/>

VPN->IPSec

- **Encryption Algorithm (IKE)**
Select 3DES AES-128, AES-192, or AES-256 encryption.
- **Hash Algorithm (IKE)**
Select from MD5, SHA1, SHA2 256, SHA2 384 or SHA2 512 hashing.
- **Diffie-Hellman Group (IKE)**
Negotiate (None) or use 768 (Group 1), 1024 (Group 2), 1536 (Group 5) or 2048 (Group 14) etc.
- **Lifetime (IKE)**
How long the keying channel of a connection should last before being renegotiated.
- **Encryption Algorithm (ESP)**
Select 3DES AES-128, AES-192, or AES-256 encryption.
- **Hash Algorithm (ESP)**
Select from MD5, SHA1, SHA2 256, SHA2 384 or SHA2 512 hashing.
- **Diffie-Hellman Group (ESP)**
Negotiate (None) or use 768 (Group 1), 1024 (Group 2), 1536 (Group 5) or 2048 (Group 14) etc.
- **Lifetime (ESP)**
How long a particular instance of a connection should last, from successful negotiation to expiry.
- **DPD Interval**
Enter the interval after which DPD is triggered if no IPsec protected packets is received from the peer.
- **DPD Timeout**
Enter the remote peer probe response timer.
- **Additional Configurations**
Enter some other options of IPsec in this field. Each expression can be separated by a ';'.

4.7.3 GRE

Generic Routing Encapsulation (GRE) is a protocol that encapsulates packets in order to route other protocols over IP networks. It's a tunneling technology that provides a channel through which encapsulated data message could be transmitted and encapsulation and decapsulation could be realized at both ends.

Status GRE			
GRE Information			
Index	Enable	Description	Status

VPN->GRE->Status

- **Enable**
Displays current GRE settings is enable or disable.
- **Description**
Displays the description of current VPN channel.
- **Status**
Displays the current VPN connection status.

GRE Settings

GRE Information

Index	<input type="text" value="1"/>
Enable	<input checked="" type="checkbox"/>
Description	<input type="text"/>
Remote Gateway	<input type="text"/>
Local Virtual IP	<input type="text"/>
Local Virtual Netmask	<input type="text" value="255.255.255.252"/>
Tunnel key	<input type="text"/> ?
Enable NAT	<input type="checkbox"/>

VPN->GRE

- **Enable**
Check this box to enable GRE.
- **Description**
Enter the description of current VPN channel.

- **Remote Gateway**
Enter the remote IP address of peer GRE tunnel.
- **Local Virtual IP**
Enter the local tunnel IP address of GRE tunnel.
- **Local Virtual Netmask**
Enter the local virtual netmask of GRE tunnel.
- **Tunnel Key**
Enter the authentication key of GRE tunnel.
- **Enable NAT**
Check this box to enable NAT function.

4.8 Maintenance

4.8.1 Upgrade

When newer versions of NR500 firmware become available, the user can manually update the unit by uploading a package to the unit.

NOTE: The unit automatically reboots once the upload completes, thus taking the NR500 router out of service during approximately 1 minute. Unless otherwise stated, the user is not expected to take any special precautions.

CAUTION: It is important to have a stable power source and ensure that power to the Fusion is not interrupted during a firmware upgrade.

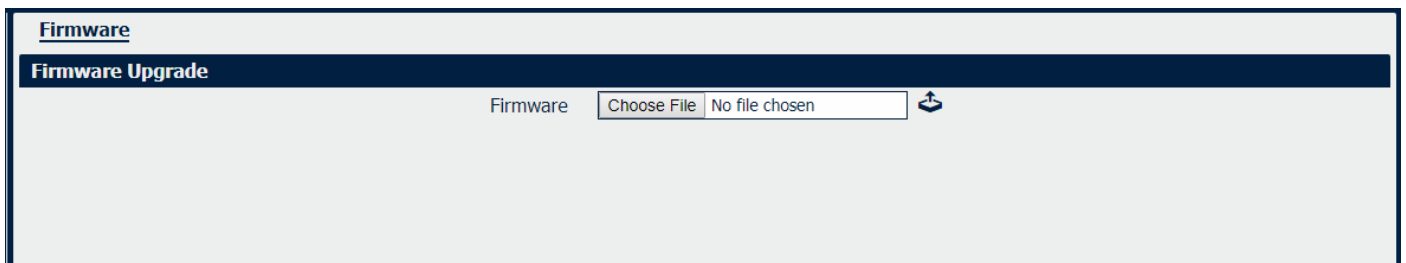

4.8.2 System

This section allows you to review the device system settings.

General	Accounts	Syslog	Web Server	Telnet	SSH	Security
General Settings						
Hostname		<input type="text" value="navigateworx.router"/>				
User LED Type		<input type="text" value="None"/>				
Time Zone Settings						
Time Zone		<input type="text" value="UTC+08:00"/>				
Customized Time Zone		<input type="text"/> ?				
Time Synchronisation						
Enable		<input checked="" type="checkbox"/>				
Primary NTP Server		<input type="text" value="pool.ntp.org"/>				
Secondary NTP Server		<input type="text" value="1.pool.ntp.org"/>				

System->General

- Hostname**
 User-defined router name, which might be use for IPSec local ID identify.
- User LED Type**
 Defined the User LED behavior.
- Time Zone**
 Select the zone where the device is in use.
- Customized Time Zone**
 Customized the zone where the device is in use.
- Enable (NTP Client)**
 Selected Enabled to utilize the NTP client to synchronize the device clock over the network using a time server (NTP server).
- Primary NTP Server**
 Enter the IP address (or host name) of the primary time server.
- Secondary NTP Server**
 Enter the IP address (or host name) of the secondary time server.

General	Accounts	Syslog	Web Server	Telnet	SSH	Security
Account Settings						
Administrator		<input type="text" value="admin"/>				
Old Password		<input type="text"/>				
New Password		<input type="text"/>				
Confirm Password		<input type="text"/>				
Visitor Settings						
Index	Username	Password	+			

System->Account

- **Administrator**
Displays the name of current administrator, default as "admin".
- **Old Password**
Enter the old password of administrator.
- **New Password**
Enter the new password of administrator.
- **Confirm Password**
Confirm the new password of administrator.

Account Settings	
Account Settings	
Index	<input type="text" value="1"/>
Username	<input type="text"/>
Password	<input type="text"/>
<input type="button" value="Save"/> <input type="button" value="Close"/>	

System->Account

- **Username**
Enter a username of visitor privilege
- **Password**
Enter the new password of current visitor account.

Syslog displays system logs that are stored in the log buffers.

General	Accounts	<u>Syslog</u>	Web Server	Telnet	SSH	Security
General Settings						
		Log Location	RAM			
		Log Level	Debug			
Remote Syslog Settings						
		Enable Remote Syslog	<input type="checkbox"/>			
		Remote Syslog Server				
		Remote Syslog Port	514			

System->Syslog

- **Log Location**
Select the log store location from "RAM" or "Flash".
- **Log Level**
Select the log output level from "Debug", "Notice", "Info", "Warning" or "Error".
- **Enable Remote Syslog**
Check this box to enable remote syslog connection.
- **Remote Syslog Server**
Enter the IP address of remote syslog server.
- **Remote Syslog Port**
Enter the port for remote syslog server listening.

General	Accounts	Syslog	<u>Web Server</u>	Telnet	SSH	Security
General Settings						
			HTTP Port	80		
			HTTPS Port	443		
Certificate Settings						
			Private Key	Choose File	No file chosen	
			Certificate File	Choose File	No file chosen	

System->Web Server

- **HTTP Port**
Enter the port for Hypertext Transfer Protocol. A well-known port for HTTP is port 80.
- **HTTPS Port**
Enter the port for HTTPS Protocol. A well-known port for HTTPS is port 443.
- **Private Key**
Import private Key file for HTTPS connection.
- **Certificate File**
Import certificate file for HTTPS connection.

General	Accounts	Syslog	Web Server	<u>Telnet</u>	SSH	Security
General Settings						
		Telnet Port	<input type="text" value="23"/>			

System->Telnet

- **Telnet Port**
Enter the port for telnet access. A well-known port for HTTP is port 23.

General	Accounts	Syslog	Web Server	Telnet	<u>SSH</u>	Security
General Settings						
		SSH Port	<input type="text" value="22"/>			
		Allow Password Authentication	<input checked="" type="checkbox"/>			
		Public Key	<input type="text"/>			

System->SSH

- **SSH Port**
Enter the port for SSH access. A well-known port for HTTP is port 22.
- **Allow Password Authentication**
Check this box to enable SSH authentication.
- **Public Key**
Enter the public Key SSH authentication.

General	Accounts	Syslog	Web Server	Telnet	SSH	<u>Security</u>
Remote Access Settings						
		Remote HTTP Access	<input checked="" type="checkbox"/>			
		Remote HTTPS Access	<input checked="" type="checkbox"/>			
		Remote Telnet Access	<input type="checkbox"/>			
		Remote SSH Access	<input checked="" type="checkbox"/>			

System->Security

- **Remote HTTP Access**
Check this box to allow remote HTTP access.
- **Remote HTTPS Access**
Check this box to allow remote HTTPS access.
- **Remote Telnet Access**

Check this box to allow remote Telnet access.

- **Remote SSH Access**

Check this box to allow remote SSH access.

4.8.3 Configuration

The Unit Configuration tab allows you to save parameters (settings in the Web interface) to a file. Conversely, if you have saved settings from the NR500 router to a file, you can Import these previously-saved configuration settings to the NR500 router as well.

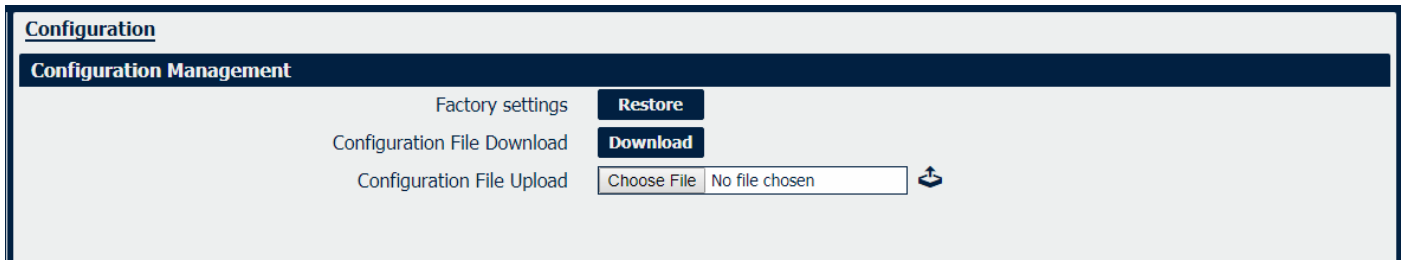

System->Configuration

- **Restore**
Reset the unit to factory default settings.
- **Download**
Download the configuration file from NR500 router.
- **Configuration File Upload**
Import previously-saved configuration file.

4.8.4 Debug Tools

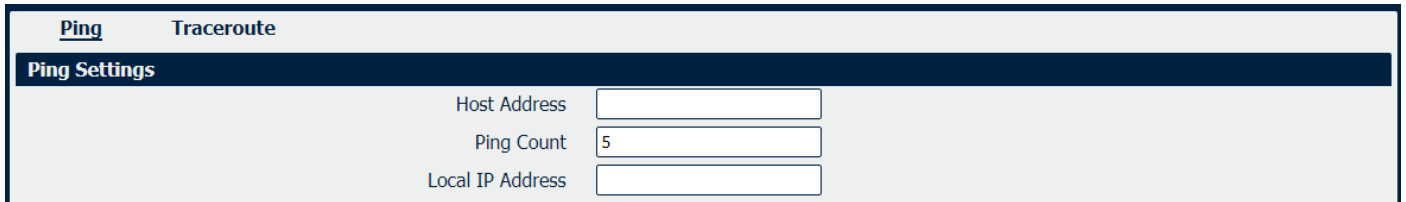

Debug Tools->Ping

- **Host Address**
Enter a host IP address or domain name for ping.
- **Ping Count**
Enter the ping times.
- **Local IP Address**
Enter the ping source IP address or leave it blank.

Ping	Traceroute
Traceroute Settings	
Host Address	<input type="text"/>
Max Hops	<input type="text" value="30"/>

Debug Tools->Traceroute

- **Host Address**
Enter a host IP address or domain name for traceroute.
- **Max Hops**
Enter the max hops for traceroute.

Appendix A -Glossary

APN:	Access Point Name
GPRS:	General Packet Radio Service
HSPA:	High Speed Packet Access
HSDPA:	High-Speed Downlink Packet Access
HSUPA:	High-Speed Uplink Packet Access
LTE:	3GPP Long Term Evolution
IMEI:	International Mobile Equipment Identity
ICCID:	Integrated Circuit Card Identifier
PIN:	Personal Identification Number
PPP:	Point-to-Point Protocol
RSSI:	Received Signal Strength Indication
SIM:	Subscriber Identity Module
SMS:	Short Message Service
DHCP:	Dynamic Host Configuration Protocol
LAN:	Local Area Network
LED:	Light-Emitting Diode
NTP:	Network Time Protocol
SMA:	SubMiniature version A (connector)
SSID:	Service Set Identifier
TCP/IP:	Transmission Control Protocol / Internet Protocol
UDP:	User Datagram Protocol
VPN:	Virtual Private Network
Wi-Fi or WiFi:	Wireless Fidelity
VDC:	Voltage, Direct Current

Appendix B - Q&A

No Signal

Phenomenon

NR500 Router modem status show no signal.

Possible Reason

- Antenna installation is wrong.
- Modem failure.

Solution

- Check the LTE antenna or replace with new one.
- Check the cellular page confirm modem is detected correctly or not.

Cannot detect SIM card

Phenomenon

NR500 Router cannot detect SIM card, cellular is not failed to connect to base station.

Possible Reason

- SIM card damage.
- SIM bad contact.

Solution

- Replace SIM card.
- Re-install SIM card.

Poor Signal

Phenomenon

NR500 Router no signal or poor signal.

Possible Reason

- Antenna installation is wrong.
- Area signal weak.

Solution

- Check the antenna and re-connect it.
- Contact Telecom Operator to confirm signal problem.
- Change to high-gain antenna.

IPSec VPN established, but LAN to LAN cannot communicate

Phenomenon

IPSec VPN established, but LAN to LAN cannot communicate

Possible Reason

- Both subnets are not match the interested traffic.
- IPSec second phase (ESP) settings is not match.

Solution

- Check the both subnet settings.
- Check IPSec second phase (ESP) setting.

Forget Router Password

Phenomenon

Forget router login password.

Possible Reason

User has changed the password.

Solution

After router power on, press RESET button between 3 to 10 seconds then release, router will automatically reboot and reset to factory default settings (Username/Password is admin/admin).

Appendix C - Digital IO Scenario

Digital Input

Typical Application Diagram

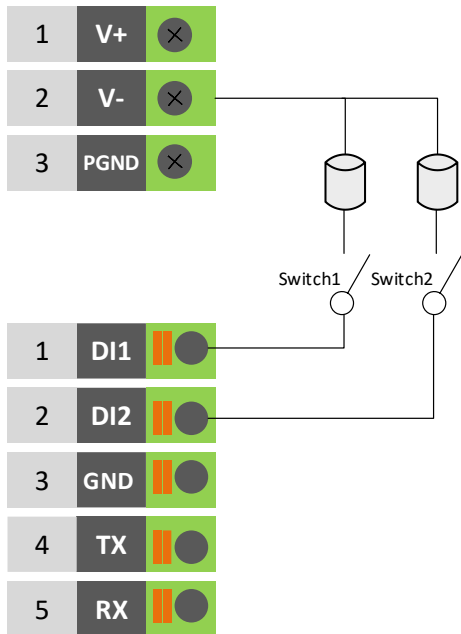

DI ELECTRICAL CHARACTERISTICS

- 1、galvanic isolation;
- 2、Over-Voltage Protection: 36 VDC
- 3、Over-Current Protection: 100mA per channel @ 25°C

Dry Contact Typical Application

- Switch ON(Short to V-): DI Logic LOW
- Switch OFF(Open): DI Logic HIGH

Digital Output

Typical Application Diagram

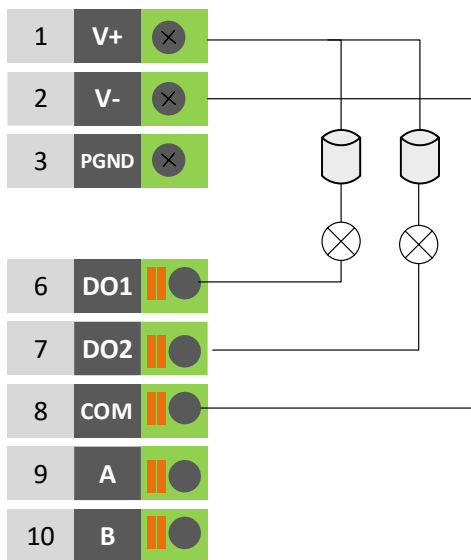

DO ELECTRICAL CHARACTERISTICS

- 1、galvanic isolation;
- 2、Over-Voltage Protection: 36 VDC

Wet Contact Typical Application

- DO Logic LOW: Switch ON(Led ON)
- DO Logic HIGH: Switch OFF(Led OFF)

Appendix D - CLI

Command-line interface (CLI) is a software interface that provide another configurable way to set parameters on our router. We could use Telnet or SSH connect to our router for CLI input.

NR500 CLI Access

navigateworx.router login: **admin**

Password: **admin**

>

CLI reference commands

>?

config	Change to the configuration mode
exit	Exit this CLI session
help	Display an overview of the CLI syntax
ping	Ping
reboot	Reboot system
show	Show running configuration or running status
telnet	Telnet Client
traceroute	TraceRoute
upgrade	Upgrade firmware
version	Show firmware version

e.g.

```
> version
1.0.0 (1017.4)
```

```
> show wifi
wifi
{
  "status":"Ready",
  "mac":"a8:3f:a1:e0:ab:81",
  "ssid":"NR500-WAN",
  "channel":"6",
  "width":"40 MHz",
  "txpower":"20.00 dBm"
}
```

```
> ping www.baidu.com
PING www.baidu.com (14.215.177.38): 56 data bytes
64 bytes from 14.215.177.38: seq=0 ttl=54 time=10.826 ms
```

```
64 bytes from 14.215.177.38: seq=1 ttl=54 time=10.284 ms
64 bytes from 14.215.177.38: seq=2 ttl=54 time=10.073 ms
64 bytes from 14.215.177.38: seq=3 ttl=54 time=10.031 ms
64 bytes from 14.215.177.38: seq=4 ttl=54 time=10.347 ms
```

```
--- www.baidu.com ping statistics ---
```

```
5 packets transmitted, 5 packets received, 0% packet loss
round-trip min/avg/max = 10.031/10.312/10.826 ms
```

```
>
```

How to Configure the CLI

CONTEXT SENSITIVE HELP

[?] - Display context sensitive help. This is either a list of possible command completions with summaries, or the full syntax of the current command. A subsequent repeat of this key, when a command has been resolved, will display a detailed reference.

AUTO-COMPLETION

The following keys both perform auto-completion for the current command line. If the command prefix is not unique then the bell will ring and a subsequent repeat of the key will display possible completions.

[enter] - Auto-completes, syntax-checks then executes a command. If there is a syntax error then offending part of the command line will be highlighted and explained.

[space] - Auto-completes, or if the command is already resolved inserts a space.

MOVEMENT KEYS

[CTRL-A] - Move to the start of the line

[CTRL-E] - Move to the end of the line.

[up] - Move to the previous command line held in history.

[down] - Move to the next command line held in history.

[left] - Move the insertion point left one character.

[right] - Move the insertion point right one character.

DELETION KEYS

[CTRL-C] - Delete and abort the current line

[CTRL-D] - Delete the character to the right on the insertion point.

[CTRL-K] - Delete all the characters to the right of the insertion point.

[CTRL-U] - Delete the whole line.

[backspace] - Delete the character to the left of the insertion point.

ESCAPE SEQUENCES

!! - Substitute the the last command line.

!N - Substitute the Nth command line (absolute as per 'history' command)

!-N - Substitute the command line entered N lines before (relative)