

User Manual

Rack/Tower Online UPS 1K/1.5K/2K/3K

Uninterruptible Power Supply System

Version: 1.4

Table of Contents

1. Important Safety Warning.....	1
1-1. Transportation.....	1
1-2. Preparation	1
1-3. Installation	1
1-4. Operation	1
1-5. Maintenance, service and faults	2
2. Installation and setup.....	3
2-1 Rear panel view	3
2-2. Install the UPS	4
2-3. Setup the UPS.....	5
2-4 Battery Replacement	6
2-5 Battery Kit Assembly (option).....	7
3. Operations.....	10
3-1. Button operation	10
3-2. LCD Panel	11
3-3. Audible Alarm	12
3-4. LCD display wordings index	12
3-5. UPS Setting	13
3-6. Operating Mode Description.....	18
3-7. Faults Reference Code	19
3-8. Warning indicator	19
4. Troubleshooting	20
5. Storage and Maintenance	22
6. Specifications.....	23

1. Important Safety Warning

Please comply with all warnings and operating instructions in this manual strictly. Save this manual properly and read carefully the following instructions before installing the unit. Do not operate this unit before reading through all safety information and operating instructions carefully

1-1. Transportation

- Please transport the UPS system only in the original package to protect against shock and impact.

1-2. Preparation

- Condensation may occur if the UPS system is moved directly from cold to warm environment. The UPS system must be absolutely dry before being installed. Please allow at least two hours for the UPS system to acclimate the environment.
- Do not install the UPS system near water or in moist environments.
- Do not install the UPS system where it would be exposed to direct sunlight or near heater.
- Do not block ventilation holes in the UPS housing.

1-3. Installation

- Do not connect appliances or devices which would overload the UPS system (e.g. laser printers) to the UPS output sockets.
- Place cables in such a way that no one can step on or trip over them.
- Do not connect domestic appliances such as hair dryers to UPS output sockets.
- The UPS can be operated by any individuals with no previous experience.
- Connect the UPS system only to an earthed shockproof outlet which must be easily accessible and close to the UPS system.
- Please use only VDE-tested, CE-marked mains cable (e.g. the mains cable of your computer) to connect the UPS system to the building wiring outlet (shockproof outlet).
- Please use only VDE-tested, CE-marked power cables to connect the loads to the UPS system.
- When installing the equipment, it should ensure that the sum of the leakage current of the UPS and the connected devices does not exceed 3.5mA.

1-4. Operation

- Do not disconnect the mains cable on the UPS system or the building wiring outlet (shockproof socket outlet) during operations since this would cancel the protective earth of the UPS system and of all connected loads.
- The UPS system features its own, internal current source (batteries). The UPS output sockets or output terminals block may be electrically live even if the UPS system is not connected to the building wiring outlet.
- In order to fully disconnect the UPS system, first press the OFF/Enter button to disconnect the mains.
- Prevent no fluids or other foreign objects from inside of the UPS system.

1-5. Maintenance, service and faults

- The UPS system operates with hazardous voltages. Repairs may be carried out only by qualified maintenance personnel.
- **Caution** - risk of electric shock. Even after the unit is disconnected from the mains (building wiring outlet), components inside the UPS system are still connected to the battery and electrically live and dangerous.
- Before carrying out any kind of service and/or maintenance, disconnect the batteries and verify that no current is present and no hazardous voltage exists in the terminals of high capability capacitor such as BUS-capacitors.
- Only persons are adequately familiar with batteries and with the required precautionary measures may replace batteries and supervise operations. Unauthorized persons must be kept well away from the batteries.
- **Caution** - risk of electric shock. The battery circuit is not isolated from the input voltage. Hazardous voltages may occur between the battery terminals and the ground. Before touching, please verify that no voltage is present!
- Batteries may cause electric shock and have a high short-circuit current. Please take the precautionary measures specified below and any other measures necessary when working with batteries:
 - remove wristwatches, rings and other metal objects
 - use only tools with insulated grips and handles.
- When changing batteries, install the same number and same type of batteries.
- Do not attempt to dispose of batteries by burning them. This could cause battery explosion.
- Do not open or destroy batteries. Escaping electrolyte can cause injury to the skin and eyes. It may be toxic.
- Please replace the fuse only with the same type and amperage in order to avoid fire hazards.
- Do not dismantle the UPS system.

2. Installation and setup

NOTE: Before installation, please inspect the unit. Be sure that nothing inside the package is damaged. Please keep the original package in a safe place for future use.

NOTE: There are two different types of online UPS: standard and long-run models. Please refer to the following model table.

Model No.	Type	Model No.	Type
1K	Standard	1KL	Long-run
1.5K		1.5KL	
2K		2KL	
3K		3KL	

2-1 Rear panel view

1K/1.5K IEC

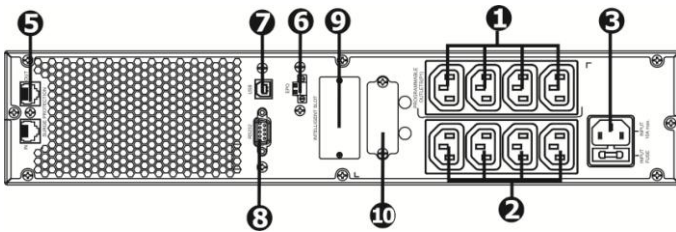

1KL/1.5KL IEC

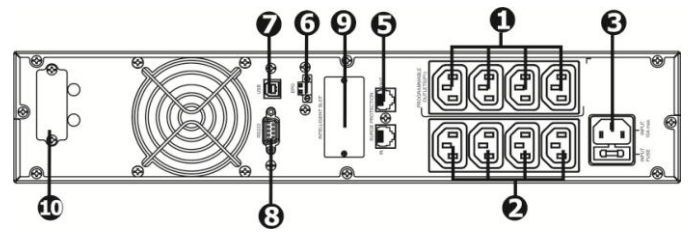

2K IEC

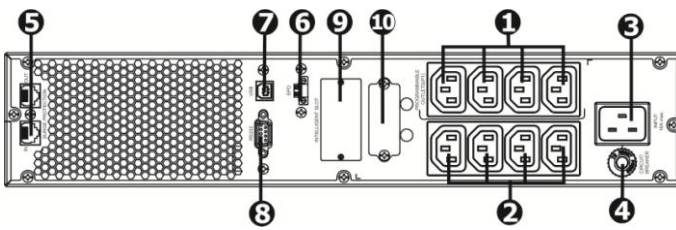

2KL IEC

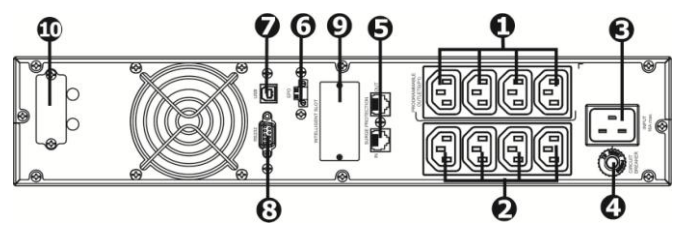

3K IEC

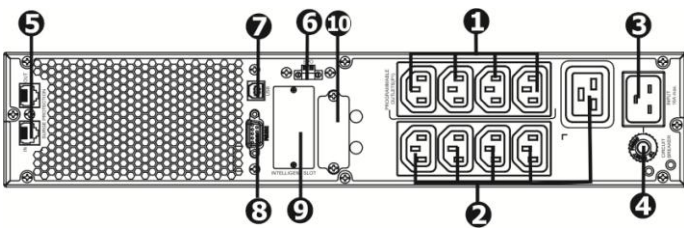

3KL IEC

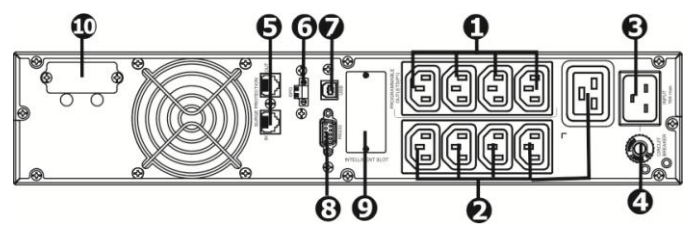

1K(L) NEMA

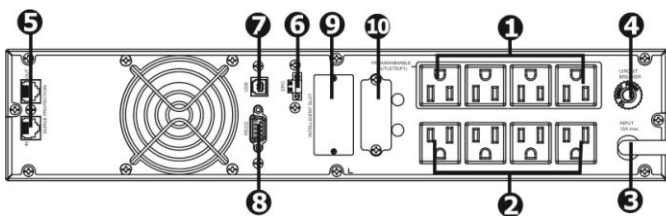

1.5K(L) NEMA

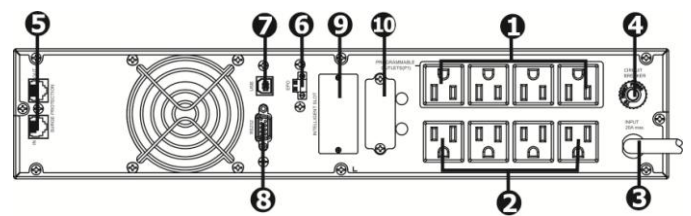

2K(L) NEMA

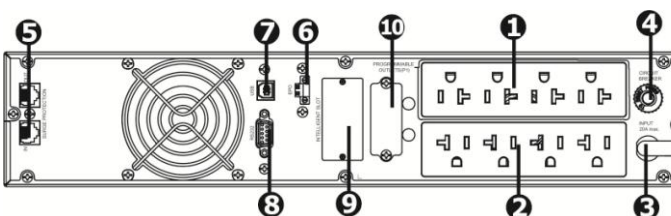

3K(L) NEMA

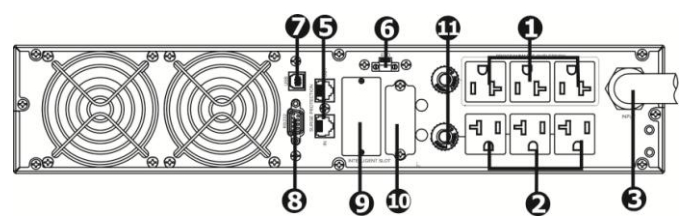

1. Programmable outlets: connect to non-critical loads.
2. Output receptacles: connect to mission-critical loads.
3. AC input
4. Input circuit breaker
5. Network/Fax/Modem surge protection
6. Emergency power off function connector (EPO)
7. USB communication port
8. RS-232 communication port
9. SNMP intelligent slot
10. External battery connector
11. Output circuit breaker

2-2. Install the UPS

For safety consideration, the UPS is shipped out from factory without connecting battery wires. Before install the UPS, please follow below steps to re-connect battery wires first.

Step 1

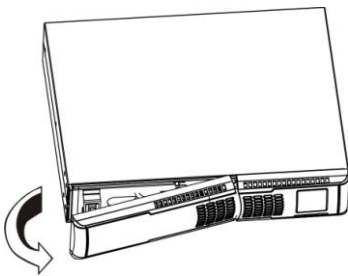

Remove front panel.

Step 2

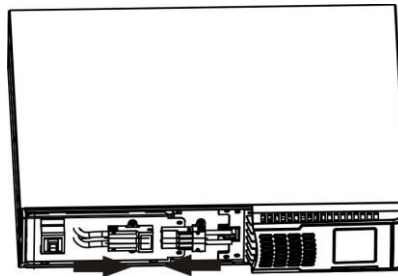

Connect the AC input and re-connect battery wires.

Step 3

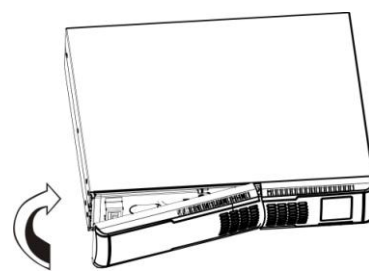

Put the front panel back to the unit.

This UPS can be either displayed on the desk or mounted in the 19" rack chassis. Please choose proper installation to position this UPS.

Rack-mount Installation

Step 1

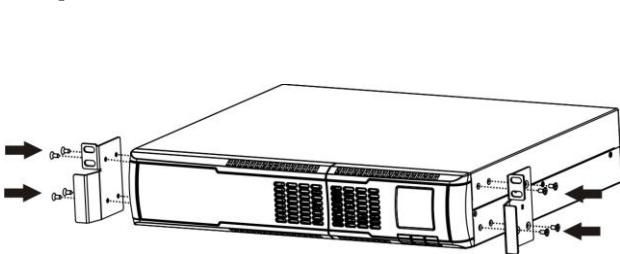

Step 2

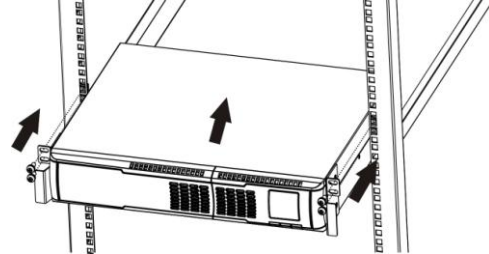

Tower Installation

Step 1

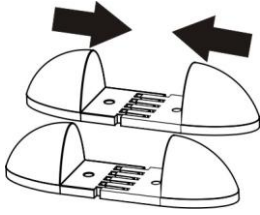

Step 2

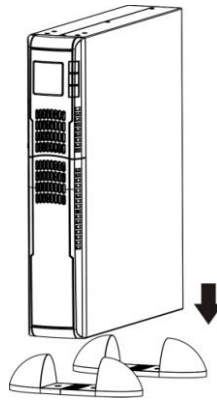

Step 3

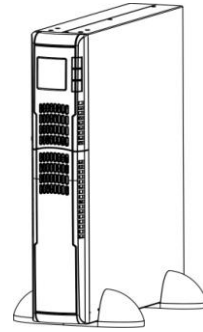

2-3. Setup the UPS

Step 1: UPS input connection

Plug the UPS into a two-pole, three-wire, grounded receptacle only. Avoid using extension cords.

Step 2: UPS output connection

For socket-type outputs, there two kinds of outputs: programmable outlets and general outlets. Please connect non-critical devices to the programmable outlets and critical devices to the general outlets. During power failure, you may extend the backup time to critical devices by setting shorter backup time for non-critical devices.

Step 3: Communication connection

Communication port:

USB port



RS-232 port

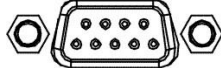

Intelligent slot



To allow for unattended UPS shutdown/start-up and status monitoring, connect the communication cable one end to the USB/RS-232 port and the other to the communication port of your PC. With the monitoring software installed, you can schedule UPS shutdown/start-up and monitor UPS status through PC.

The UPS is equipped with intelligent slot perfect for either SNMP or AS400 card. When installing either SNMP or AS400 card in the UPS, it will provide advanced communication and monitoring options.

Step 4: Network connection

Network/Fax/Phone surge port



Connect a single modem/phone/fax line into surge-protected "IN" outlet on the back panel of the UPS unit. Connect from "OUT" outlet to the equipment with another modem/fax/phone line cable.

Step 5: Disable and enable EPO function

Keep the pin 1 and pin 2 closed for UPS normal operation. To activate EPO function, cut the wire between pin 1 and pin 2.

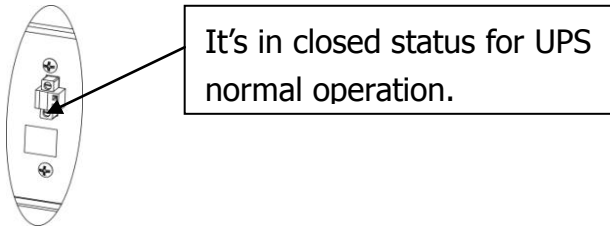

Step 6: Turn on the UPS

Press the ON/Mute button on the front panel for two seconds to power on the UPS.

Note: The battery charges fully during the first five hours of normal operation. Do not expect full battery run capability during this initial charge period.

Step 7: Install software

For optimal computer system protection, install UPS monitoring software to fully configure UPS shutdown. Please follow steps below to download and install monitoring software:

1. Go to the website <http://www.power-software-download.com>
2. Click ViewPower software icon and then choose your required OS to download the software.
3. Follow the on-screen instructions to install the software.
4. When your computer restarts, the monitoring software will appear as an orange plug icon located in the system tray, near the clock.

2-4 Battery Replacement

NOTICE: This UPS is equipped with internal batteries and user can replace the batteries without shutting down the UPS or connected loads.(hot-swappable battery design)

Replacement is a safe procedure, isolated from electrical hazards.

CAUTION!! Consider all warnings, cautions, and notes before replacing batteries.

Note: Upon battery disconnection, equipment is not protected from power outages.

Step 1

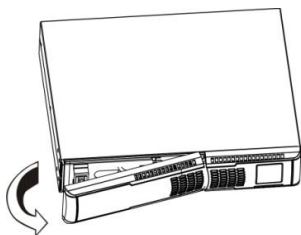

Remove front panel.

Step 2

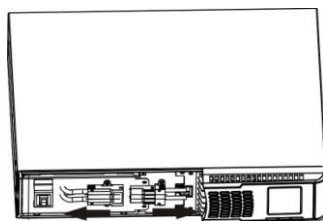

Disconnect battery wires.

Step 3

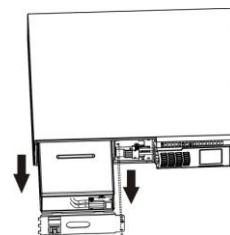

Pull out the battery box by removing two screws on the front panel.

Step 4

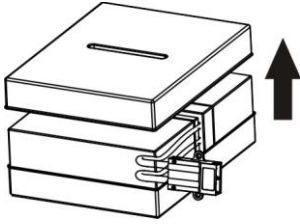

Remove the top cover of battery box and replace the inside batteries.

Step 5

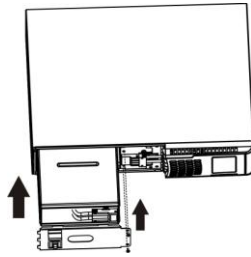

After replacing the batteries, put the battery box back to original location and screw it tightly.

Step 6

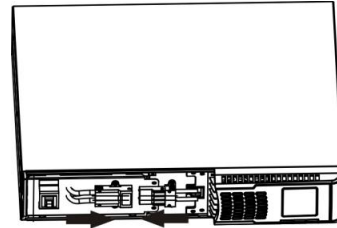

Re-connect the battery wires.

Step 7

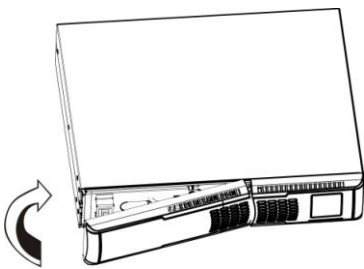

Put the front panel back to the unit.

2-5 Battery Kit Assembly (option)

NOTICE: Please assemble battery kit first before installing it inside of UPS. Please select correct battery kit procedure below to assemble it.

2-battery kit

Step 1: Remove adhesive tapes.

Tapes

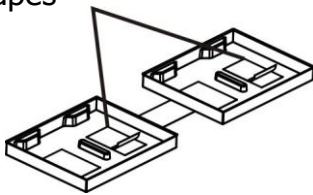

Step 3: Put assembled battery packs on one side of plastic shells.

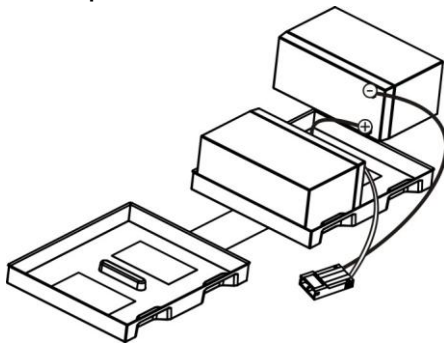

Step 2: Connect all battery terminals by following below chart.

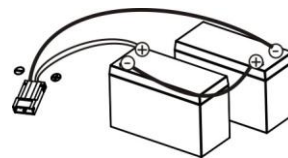

Step 4: Cover the other side of plastic shell as below chart. Then, battery kit is assembly well.

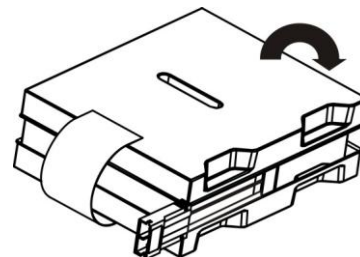

3-battery kit

Step 1: Remove adhesive tapes.

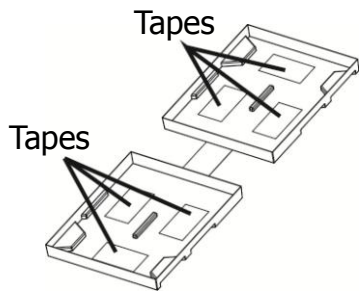

Step 2: Connect all battery terminals by following below chart.

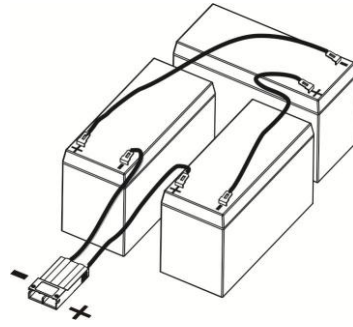

Step 3: Put assembled battery packs on one side of plastic shells as below chart.

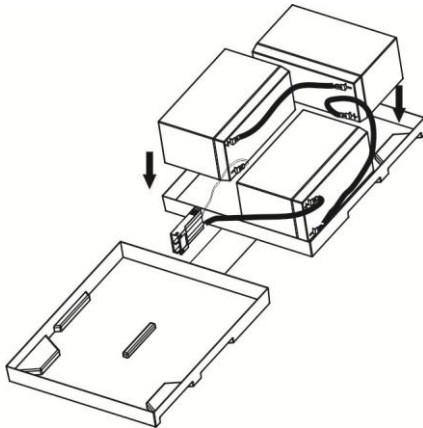

Step 4: Cover the other side of plastic shell as below chart. Then, battery kit is assembly well.

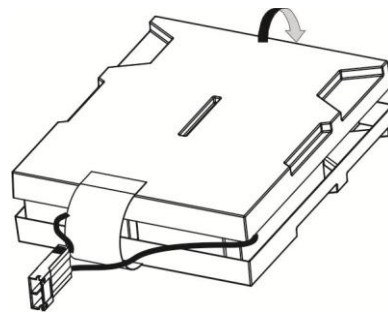

4-battery kit

Step 1: Remove adhesive tapes.

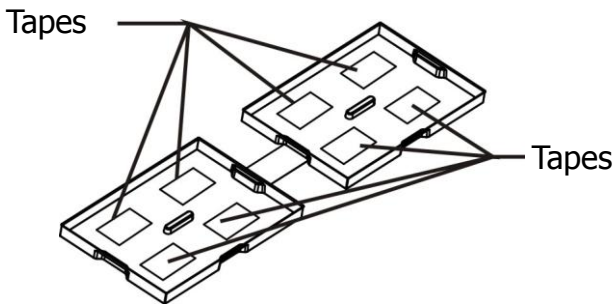

Step 2: Connect all battery terminals by following below chart.

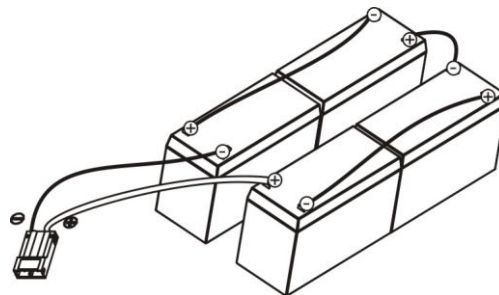

Step 3: Put assembled battery packs on one side of plastic shells.

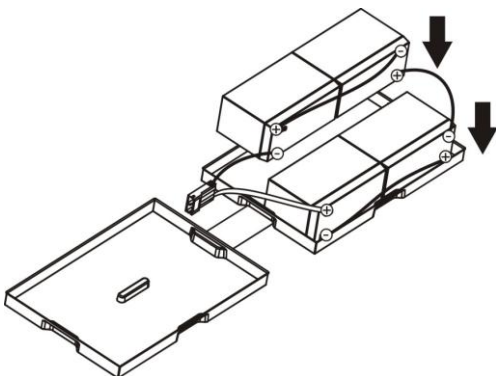

Step 4: Cover the other side of plastic shell as below chart. Then, battery kit is assembly well.

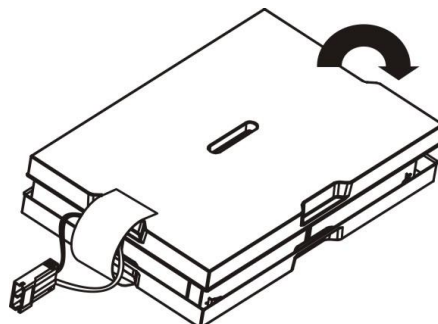

6-battery kit

Step 1: Remove adhesive tapes.

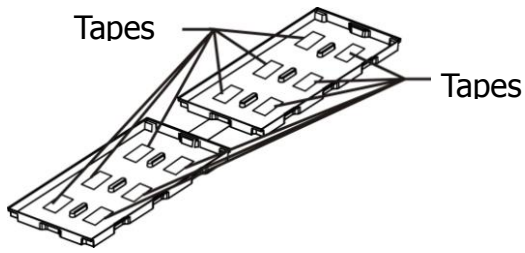

Step 2: Connect all battery terminals by following below chart.

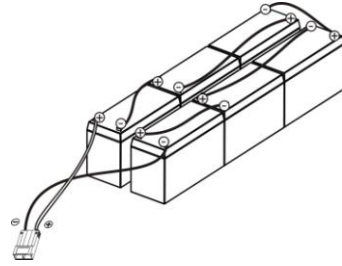

Step 3: Put assembled battery packs on one side of plastic shells.

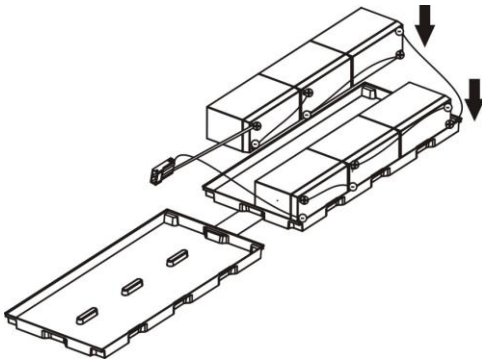

Step 4: Cover the other side of plastic shell as below chart. Then, battery kit is assembly well.

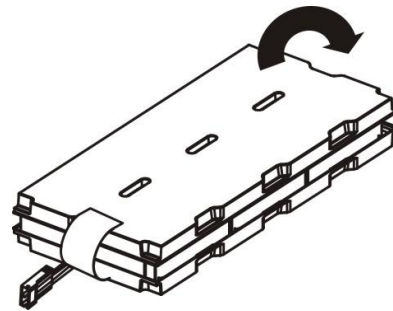

3. Operations

3-1. Button operation

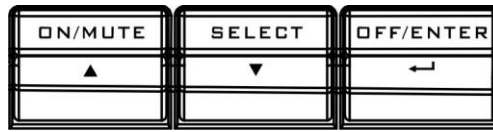

Button View

Button	Function
ON/Mute Button	<ul style="list-style-type: none"> ➤ Turn on the UPS: Press and hold ON/Mute button for at least 2 seconds to turn on the UPS. ➤ Mute the alarm: After the UPS is turned on in battery mode, press and hold this button for at least 3 seconds to disable or enable the alarm system. But it's not applied to the situations when warnings or errors occur. ➤ Up key: Press this button to display previous selection in UPS setting mode. ➤ Switch to UPS self-test mode: Press ON/Mute buttons for 3 seconds to enter UPS self-testing while in AC mode, ECO mode, or converter mode.
OFF/Enter Button	<ul style="list-style-type: none"> ➤ Turn off the UPS: Press and hold this button at least 2 seconds to turn off the UPS. UPS will be in standby mode under power normal or transfer to Bypass mode if the Bypass enable setting by pressing this button. ➤ Confirm selection key: Press this button to confirm selection in UPS setting mode.
Select Button	<ul style="list-style-type: none"> ➤ Switch LCD message: Press this button to change the LCD message for input voltage, input frequency, battery voltage, output voltage and output frequency. ➤ Setting mode: Press and hold this button for 3 seconds to enter UPS setting mode when Standby and Bypass mode. ➤ Down key: Press this button to display next selection in UPS setting mode.
ON/Mute + Select Button	<ul style="list-style-type: none"> ➤ Switch to bypass mode: When the main power is normal, press ON/Mute and Select buttons simultaneously for 3 seconds. Then UPS will enter to bypass mode. This action will be ineffective when the input voltage is out of acceptable range. ➤ Exit setting mode or return to the upper menu: When working in setting mode, press ON/Mute and Select buttons simultaneously for 0.2 seconds to return to the upper menu. If it's already in top menu, press these two buttons at the same time to exit the setting mode.
Select + OFF/Enter Button	<ul style="list-style-type: none"> ➤ Rack or Tower display switch: Press Select and OFF/Enter buttons simultaneously for 3 seconds. The display change from/to Rack to/from Tower.

3-2. LCD Panel

Rack Display

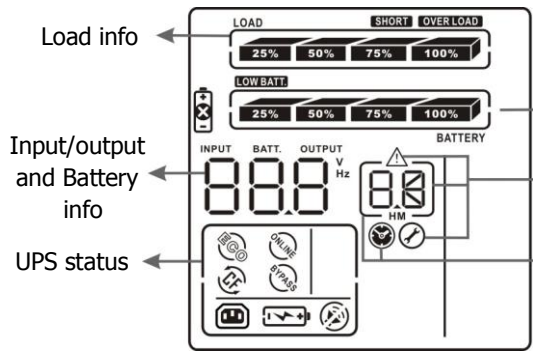

Load info
Input/output and Battery info
UPS status

Battery info
Warning & Fault info/ Setting operation
Backup time info

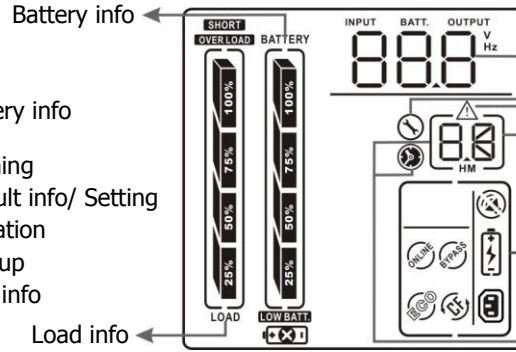

Tower Display



Battery info
Warning & Fault info/ Setting operation
Backup time info
Load info

Input/output and Battery info
Warning & Fault info/ Setting operation
UPS status
Backup time info

Display	Function
Backup time information	
	Indicates the backup time in pie chart.
	Indicates the backup time in numbers. H: hours, M: minute
Warning & Fault information	
	Indicates that the warning and fault occurs.
	Indicates the warning and fault codes, and the codes are listed in details in 3-5 section.
Setting Operation	
	Indicates the setting operation.
Input/Output & Battery information	
	Indicates input voltage, input frequency, battery voltage, output voltage and output frequency. V: voltage, Hz: frequency
Load information	
	Indicates the load level by 0-24%, 25-49%, 50-74%, and 75-100%.
	Indicates overload.
	Indicates the load or the UPS output is short circuited.
UPS status	
	Indicates that programmable management outlets are working.
	Indicates the UPS working in line mode.
	Indicates the UPS is working in converter mode.
	Indicates the UPS is working in bypass mode.
	Indicates the UPS powers the output directly from the mains
	Indicates that the UPS alarm is disabled.
	Indicates the battery charger is working.

Battery information	
	Indicates the Battery level by 0-24%, 25-49%, 50-74%, and 75-100%.
	Indicates low battery.
	Indicates there is something wrong with battery.

3-3. Audible Alarm

Battery Mode	Sounding every 5 seconds
Low Battery	Sounding every 2 seconds
Overload	Sounding every second
Fault	Continuously sounding

3-4. LCD display wordings index

Abbreviation	Display content	Meaning
ENA	ENR	Enable
DIS	di S	Disable
ESC	ESC	Escape
HS	HS	High loss
LS	LS	Low loss
ON	ON	ON
OK	OK	OK
SF	SF	Site fault
EP	EP	EPO
TP	TP	Temperature
CH	CH	Charger
FU	FU	Bypass frequency unstable
EE	EE	EEPROM error
FA	FA	Fan failure
BR	br	Battery Replacement

3-5. UPS Setting

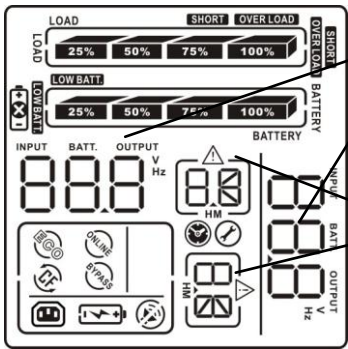

Parameter 2

There are two parameters to set up the UPS.

Parameter 1: It's for program alternatives. There are 16 programs to set up.

Parameter 2: It's setting options or values for each program.

Parameter 1

➤ 01: Output voltage setting

Interface	Setting
	<p>Parameter 2: Output voltage</p> <p>For 200/208/220/230/240 VAC models, you may choose the following output voltage:</p> <p>200: presents output voltage is 200Vac 208: presents output voltage is 208Vac 220: presents output voltage is 220Vac 230: presents output voltage is 230Vac (Default) 240: presents output voltage is 240Vac</p> <p>For 100/110/150/120/127 VAC models, you may choose the following output voltage:</p> <p>100: presents output voltage is 100Vac 110: presents output voltage is 110Vac 115: presents output voltage is 115Vac 120: presents output voltage is 120Vac (Default) 127: presents output voltage is 127Vac</p>

➤ 02: Frequency Converter enable/disable

Interface	Setting
	<p>Parameter 2: Enable or disable converter mode. You may choose the following two options:</p> <p>CF ENA: converter mode enable CF DIS: converter mode disable (Default)</p>

➤ 03: Output frequency setting

Interface	Setting
	<p>Parameter 2: Output frequency setting.</p> <p>You may set the initial frequency on battery mode:</p> <p>BAT 50: presents output frequency is 50Hz BAT 60: presents output frequency is 60Hz</p> <p>If converter mode is enabled, you may choose the following output frequency:</p> <p>CF 50: presents output frequency is 50Hz CF 60: presents output frequency is 60Hz</p>

➤ **04: ECO enable/disable**

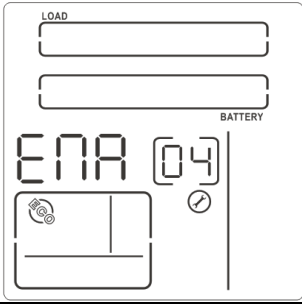
Interface	Setting
	<p>Parameter 2: Enable or disable ECO function. You may choose the following two options: ENA: ECO mode enable DIS: ECO mode disable (Default)</p>

➤ **05: AECO enable/disable**

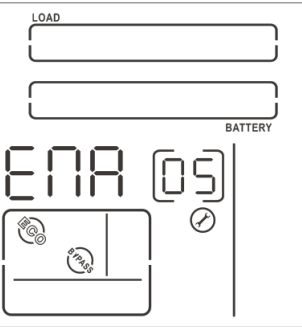
Interface	Setting
	<p>ENA: Advanced ECO mode enable DIS: Advanced ECO mode disable (Default)</p>

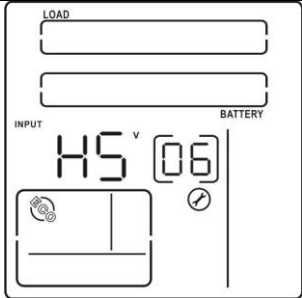
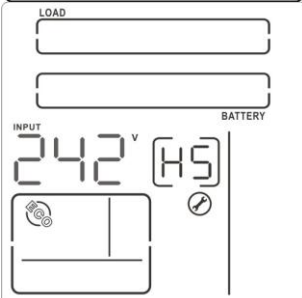
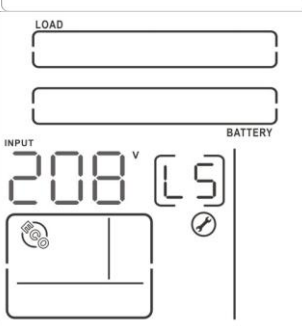

➤ **06: ECO voltage range setting**

Interface	Setting
	<p>Parameter 1 & 2: Set the acceptable high voltage point and low voltage point for ECO & AECO mode by pressing Down key or Up key. HS: High loss voltage in ECO & AECO mode in parameter 2. For 200/208/220/230/240 VAC models, the setting range in parameter 3 is from +7V to +24V of the nominal voltage. (Default: +12V) For 100/110/115/120/127 VAC models, the setting range in parameter 3 is from +3V to +12V of the nominal voltage. (Default: +6V)</p>
	<p>LS: Low loss voltage in ECO & AECO mode in parameter 2. For 200/208/220/230/240 VAC models, the setting range in parameter 3 is from -7V to -24V of the nominal voltage. (Default: -12V) For 100/110/115/120/127 VAC models, the setting voltage in parameter 3 is from -3V to -12V of the nominal voltage. (Default: -6V)</p>
	

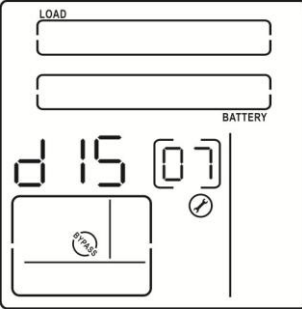
➤ **07: Bypass enable/disable when UPS is off**

Interface	Setting
	<p>Parameter 2: Enable or disable Bypass function. You may choose the following two options:</p> <p>ENA: Bypass enable</p> <p>DIS: Bypass disable (Default)</p>

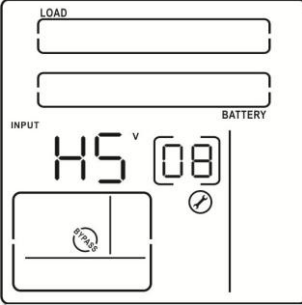
➤ **08: Bypass voltage range setting**

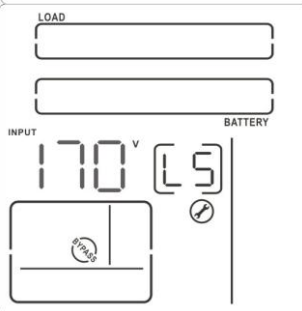
Interface	Setting
	<p>Parameter 1 & 2: Set the acceptable high voltage point and acceptable low voltage point for Bypass mode by pressing the Down key or Up key.</p> <p>HS: Bypass high voltage point</p> <p>For 200/208/220/230/240 VAC models: 230-264: setting the high voltage point in parameter 3 from 230Vac to 264Vac. (Default: 264Vac)</p> <p>For 100/110/115/120/127 VAC models: 120-140: setting the high voltage point in parameter 3 from 120Vac to 140Vac(Default: 132Vac)</p>
	<p>LS: Bypass low voltage point</p> <p>For 200/208/220/230/240 VAC models: 170-220: setting the low voltage point in parameter 3 from 170Vac to 220Vac (Default: 170Vac)</p> <p>For 100/110/115/120/127 VAC models: 85-115: setting the low voltage point in parameter 3 from 85Vac to 115Vac. (Default: 85Vac)</p>
	

➤ **09: Bypass frequency range setting**

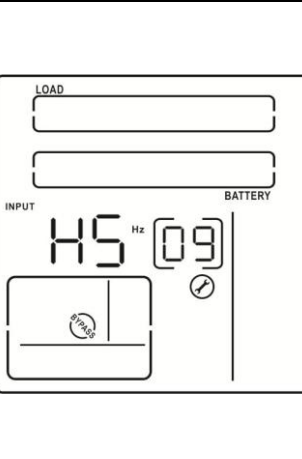
Interface	Setting
	<p>Parameter 1 & 2:Set the acceptable high frequency point and acceptable low frequency point for Bypass mode by pressing the Down key or Up key.</p> <p>HS: Bypass high frequency point</p> <p>For 50Hz output frequency models: 51-55Hz: setting the frequency high loss point from 51Hz to 55HZ (Default: 53.0Hz)</p> <p>For 60Hz output frequency models: 61-65Hz: setting the frequency high loss point from 61Hz to 65Hz (Default: 63.0Hz)</p> <p>LS: Bypass low Frequency point</p> <p>For 50Hz output frequency models:</p>

	<p>45-49Hz: setting the frequency low loss point from 45Hz to 49Hz (Default: 47.0Hz) For 60Hz output frequency models: 55-59Hz: setting the frequency low loss point from 55Hz to 59Hz (Default: 57.0Hz)</p>
--	--

➤ **10: Programmable outlets enable/disable**

Interface	Setting
	<p>Parameter 2: Enable or disable programmable outlets. ENA: Programmable outlets enable DIS: Programmable outlets disable (Default)</p>

➤ **11: Programmable outlets setting**

Interface	Setting
	<p>Parameter 2: Set up backup time limits for programmable outlets. 0-999: setting the backup time limits in minutes from 0-999 for programmable outlets which connect to non-critical devices on battery mode. (Default: 999)</p>

➤ **12: Autonomy limitation setting**

Interface	Setting
	<p>Parameter 2: Set up backup time on battery mode for general outlets. 0-999: setting the backup time in minutes from 0-999 for general outlets on battery mode. DIS: Disable the autonomy limitation and the backup time will depend on battery capacity. (Default) Note: When setting as "0", the backup time will be only 10 seconds.</p>

➤ **13: Battery total AH setting**

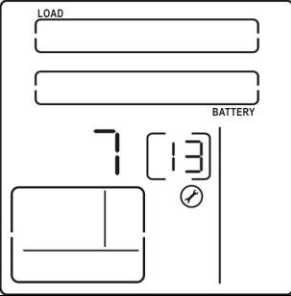
Interface	Setting
 <p>The interface diagram shows a digital display with two fields labeled 'LOAD' and 'BATTERY'. The 'LOAD' field is empty. The 'BATTERY' field shows the number '7'. To the right of the 'BATTERY' field is a bracketed number '[13]'. Below the display is a battery icon and a power button.</p>	<p>Parameter 2: Set up the battery total AH of the UPS. 7-999: setting the battery total capacity from 7-999 in AH. Please set the correct battery total capacity if external battery bank is connected.</p>

➤ **14: Maximum charger current setting**

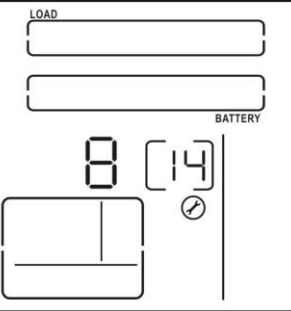
Interface	Setting
 <p>The interface diagram shows a digital display with two fields labeled 'LOAD' and 'BATTERY'. The 'LOAD' field is empty. The 'BATTERY' field shows the number '8'. To the right of the 'BATTERY' field is a bracketed number '[14]'. Below the display is a battery icon and a power button.</p>	<p>Parameter 2: Set up the maximum charger current. When the UPS is equipped with additional charger, the available setting options are 2/3/4. 2/3/4: setting the maximum charger current in 2/3/4 Ampere. When the UPS is long run model, the available setting options are 1/2/4/6/8. 1/2/4/6/8: setting the maximum charger current in 1/2/4/6/8 Ampere. (Default: 8A)</p>

➤ **15: Charger Boost voltage setting**

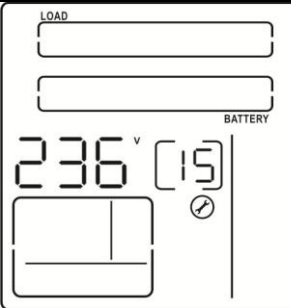
Interface	Setting
 <p>The interface diagram shows a digital display with two fields labeled 'LOAD' and 'BATTERY'. The 'LOAD' field is empty. The 'BATTERY' field shows '236' with a 'V' symbol. To the right of the 'BATTERY' field is a bracketed number '[15]'. Below the display is a battery icon and a power button.</p>	<p>Parameter 2: Set up the charger boost voltage. 225-240: setting the charger boost voltage from 225 to 240(unit: 0.01V/cell). (Default: 236)</p>

➤ **16: Charger Float voltage setting**

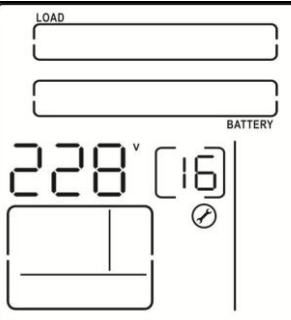
Interface	Setting
 <p>The interface diagram shows a digital display with two fields labeled 'LOAD' and 'BATTERY'. The 'LOAD' field is empty. The 'BATTERY' field shows '228' with a 'V' symbol. To the right of the 'BATTERY' field is a bracketed number '[16]'. Below the display is a battery icon and a power button.</p>	<p>Parameter 2: Set up the charger float voltage. 220-233: setting the charger float voltage from 220 to 233(unit: 0.01V/cell). (Default:228)</p>

➤ **00: Exit setting**

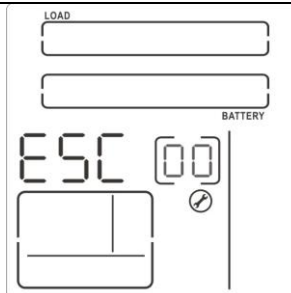

Interface	Setting
 <p>The interface diagram shows a digital display with two fields labeled 'LOAD' and 'BATTERY'. The 'LOAD' field is empty. The 'BATTERY' field shows 'ESC'. To the right of the 'BATTERY' field is a bracketed number '[00]'. Below the display is a battery icon and a power button.</p>	<p>Exit the setting mode.</p>

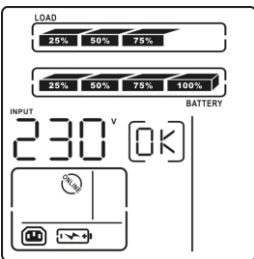
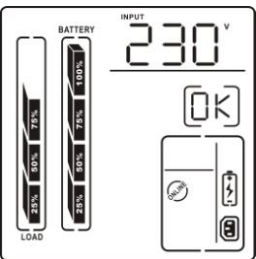
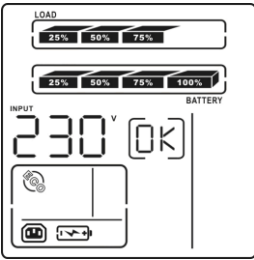
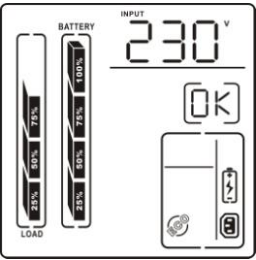
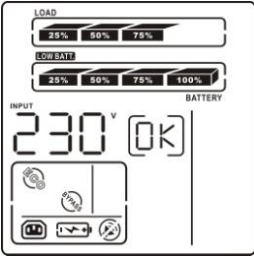
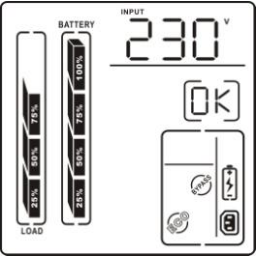
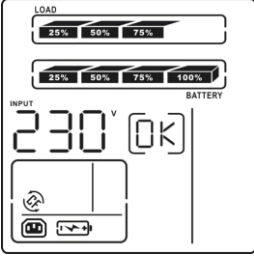
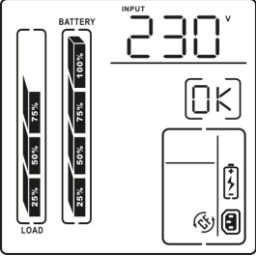
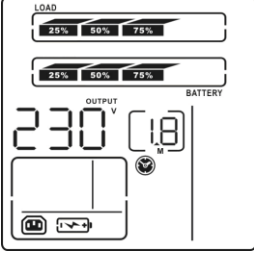
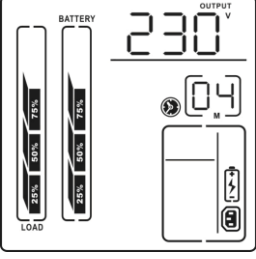
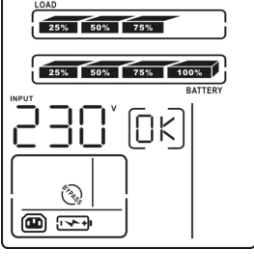
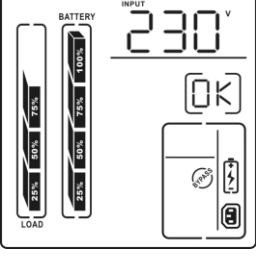
3-6. Operating Mode Description

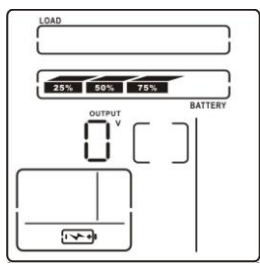
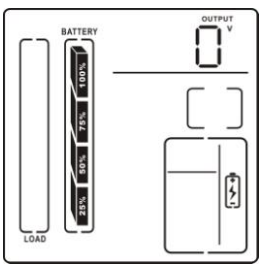
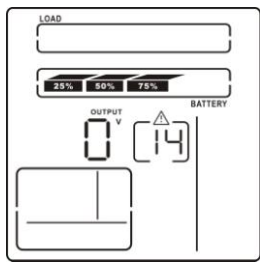
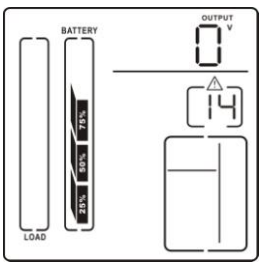











Operating mode	Description	LCD display	
		Rack Display	Tower Display
Online mode	When the input voltage is within acceptable range, UPS will provide pure and stable AC power to output. The UPS will also charge the battery at online mode.		
ECO mode	Energy saving mode: When the input voltage is within voltage regulation range, UPS will bypass voltage to output for energy saving. The UPS will also charge the battery at ECO mode.		
AECO mode (Advanced Efficiency Corrective Optimizer)	When the input voltage is within setting range ($\pm 3\%V_o$ max), UPS will bypass voltage to output for energy saving. PFC and INVERTER are off at this mode.		
Frequency Converter mode	When input frequency is within 40 Hz to 70 Hz, the UPS can be set at a constant output frequency, 50 Hz or 60 Hz. The UPS will still charge battery under this mode.		
Battery mode	When the input voltage is beyond the acceptable range or power failure, the UPS will backup power from battery and alarm is sounding every 5 second.		
Bypass mode	When input voltage is within acceptable range but UPS is overload, UPS will enter bypass mode or bypass mode can be set by front panel. Alarm is sounding every 10 second.		

Standby mode	UPS is powered off and no output supply power, but still can charge batteries.		
Fault mode	When a fault has occurred, the ERROR icon and the fault code will be displayed.		

3-7. Faults Reference Code

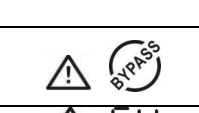

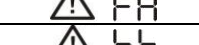



Fault event	Fault code	Icon	Fault event	Fault code	Icon
Bus start fail	01	x	Inverter output short	14	SHORT
Bus over	02	x	Battery voltage too high	27	
Bus under	03	x	Battery voltage too low	28	
Inverter soft start fail	11	x	Over temperature	41	x
Inverter voltage high	12	x	Over load	43	OVER LOAD
Inverter voltage Low	13	x	Charger failure	45	x

3-8. Warning indicator

Warning	Icon (flashing)	Alarm
Low Battery		Sounding every 2 seconds
Overload		Sounding every second
Battery is not connected		Sounding every 2 seconds
Over Charge		Sounding every 2 seconds
Site wiring fault		Sounding every 2 seconds
EPO enable		Sounding every 2 seconds
Over temperature		Sounding every 2 seconds
Charger failure		Sounding every 2 seconds
Battery fault		Sounding every 2 seconds (At this time, UPS is off to remind users of something wrong with battery)
Out of bypass voltage range		Sounding every 2 seconds
Bypass frequency unstable		Sounding every 2 seconds
EEPROM error		Sounding every 2 seconds
Fan failure		Sounding every 2 seconds
Battery replacement		Sounding every 2 seconds

4. Troubleshooting

If the UPS system does not operate correctly, please solve the problem by using the table below.

Symptom	Possible cause	Remedy
No indication and alarm even though the main is normal.	The AC input power is not connected well.	Check if input power cord firmly connected to the mains.
	The AC input is connected to the UPS output.	Plug AC input power cord to AC input correctly.
The icon  and the warning code EP flashing on LCD display and alarm is sounding every 2 seconds.	EPO function is activated.	Set the circuit in closed position to disable EPO function.
The icon  and SF flashing on LCD display and alarm is sounding every 2 seconds.	Line and neutral conductors of UPS input are reversed.	Rotate mains power socket by 180° and then connect to UPS system.
The icon  and  flashing on LCD display and alarm is sounding every 2 seconds.	The external or internal battery is incorrectly connected.	Check if all batteries are connected well.
Fault code is shown as 27 and the icon  is lighting on LCD display and alarm is continuously sounding.	Battery voltage is too high or the charger is fault.	Contact your dealer.
Fault code is shown as 28 and the icon  is lighting on LCD display and alarm is continuously sounding.	Battery voltage is too low or the charger is fault.	Contact your dealer.
The icons of  and OVERLOAD are flashing on LCD display and alarm is sounding every second.	UPS is overload	Remove excess loads from UPS output.
	UPS is overloaded. Devices connected to the UPS are fed directly by the electrical network via the Bypass.	Remove excess loads from UPS output.
	After repetitive overloads, the UPS is locked in the Bypass mode. Connected devices are fed directly by the mains.	Remove excess loads from UPS output first. Then shut down the UPS and restart it.

Symptom	Possible cause	Remedy
Fault code is shown as 43 and The icon OVERLOAD is lighting on LCD display and alarm is continuously sounding.	The UPS shut down automatically because of overload at the UPS output.	Remove excess loads from UPS output and restart it.
Fault code is shown as 14 and alarm is continuously sounding.	The UPS shut down automatically because short circuit occurs on the UPS output.	Check output wiring and if connected devices are in short circuit status.
Fault code is shown as 01, 02, 03, 11, 12, 13 and 41 on LCD display and alarm is continuously sounding.	A UPS internal fault has occurred. There are two possible results: 1. The load is still supplied, but directly from AC power via bypass. 2. The load is no longer supplied by power.	Contact your dealer
Battery backup time is shorter than nominal value	Batteries are not fully charged	Charge the batteries for at least 5 hours and then check capacity. If the problem still persists, consult your dealer.
	Batteries defect	Contact your dealer to replace the battery.
Fault code is shown as 45 on LCD display. At the same time, alarm is continuously sounding.	The charger does not have output and battery voltage is less than 10V/PC.	Contact your dealer.

5. Storage and Maintenance

Operation

The UPS system contains no user-serviceable parts. If the battery service life (3~5 years at 25°C ambient temperature) has been exceeded, the batteries must be replaced. In this case, please contact your dealer.



Be sure to deliver the spent battery to a recycling facility or ship it to your dealer in the replacement battery packing material.

Storage

Before storing, charge the UPS 5 hours. Store the UPS covered and upright in a cool, dry location. During storage, recharge the battery in accordance with the following table:

Storage Temperature	Recharge Frequency	Charging Duration
-25°C - 40°C	Every 3 months	1-2 hours
40°C - 45°C	Every 2 months	1-2 hours

6. Specifications

MODEL		1K		1.5K		2K		3K		
Capacity*	VA/W	1000 VA / 900 W		1500 VA / 1350 W		2000 VA / 1800 W		3000 VA / 2700 W		
INPUT										
Voltage Range	Low Line Transfer	80 VAC/70 VAC/60 VAC/55 VAC \pm 5 % or 160 VAC/140 VAC/120 VAC/110 VAC \pm 5 % (based on load percentage 100%-80% / 80%-70% / 70%-60% / 60%-0)								
	Low Line Comeback	85 VAC/75 VAC/65 VAC/60 VAC \pm 5 % or 170 VAC / 150 VAC / 130 VAC / 120 VAC \pm 5 %								
	High Line Transfer	150 VAC \pm 5 % or 300 VAC \pm 5 %								
	High Line Comeback	140 VAC \pm 5 % or 290 VAC \pm 5 %								
Frequency Range		40Hz ~ 70Hz								
Power Factor		\geq 0.99 @normal voltage								
OUTPUT										
Output Voltage		100*/110*/115*/120/127 VAC or 200/208/220/230/240 VAC								
AC Voltage Regulation		\pm 1%								
Frequency Range		47 ~ 53 Hz or 57 ~ 63 Hz (Synchronized Range)								
Frequency Range		50Hz \pm 0.1 Hz or 60Hz \pm 0.1 Hz (Bat. Mode)								
Current Crest Ratio (CF)		3:1 (max.)								
Harmonic Distortion (THDU)		\leq 2% THD (Linear load) ; \leq 4% THD (Non-linear load)								
Transfer Time	AC to DC	Zero								
	Inverter to Bypass	4 ms (Typical)								
Waveform (Batt. Mode)		Pure Sinewave								
EFFICIENCY										
AC Mode		90%		90%		91%		91%		
Battery Mode		88% 89%		89%		88% 89%		90%		
ECO Mode		97%		97%		97%		97%		
BATTERY										
Standard Model	Battery Type	12V/9Ah	12V/7Ah	12V/9Ah	12V/9Ah	12V/7Ah	12V/9Ah			
	Battery Numbers	2	3	3	4	6	6			
	Typical Recharge Time	4 hours recover to 90% capacity								
	Charging Current	1.5 A (Max.)**								
Long-run Model	Charging Voltage	27.4 VDC \pm 1%	41.1 VDC \pm 1%	41.1 VDC \pm 1%	54.8VDC \pm 1%	82.1VDC \pm 1%	82.1VDC \pm 1%			
	Type	Depending on application								
	Battery Numbers	2	3	3	4	6	6			
	Charging Current	1A/2A/4A/8A								
INDICATORS	LCD	UPS status, Load level, Battery level, Input/Output/battery info, Discharge time and Fault indicators								
	ALARM									
	Battery Mode	Sounding every 5 seconds								
	Low Battery	Sounding every 2 seconds								
Overload	Sounding every second									
Fault	Continuously sounding									
PHYSICAL										
Standard Model	Dimension, DxWxH (mm)	410 x 438 x 88		410 x 438 x 88		510 x 438 x 88		630 x 438 x 88		
	Net Weight (kgs)	11.6	14.2	14.5	19.5	26.9	27.4			
Long-run Model	Dimension, DxWxH (mm)	410 x 438 x 88		410 x 438 x 88		410 x 438 x 88		510 x 438 x 88		
	Net Weight (kgs)	6.4	6.4	6.5	6.5		10.5			
ENVIRONMENT										
Humidity		20-90 % RH @ 0- 40°C (non-condensing)								
Noise Level		Less than 50dBA @ 1 Meter								
MANAGEMENT										
Smart RS-232/USB		Supports Windows 2000/2003/XP/Vista/2008/7/8, Linux and MAC								
Optional SNMP		Power management from SNMP manager and web browser								

*Derate capacity to 95% when the output voltage is adjusted to 115VAC. Derate capacity to 90% when the output voltage is adjusted to 110VAC and derate capacity to 80% when the output voltage is adjusted to 100VAC/200VAC/208VAC.

**If standard UPS is equipped with additional charger, the available setting options become 2A, 3A and 4A.