

HDMI 2.0 4x4 Matrix

Best.nr: 20101609

USER MANUAL

Doc No. : OM-H4K190920 / Ver 1.0

OHM-44UHD Manual

Manual Contents

1	Introduction.....	3
1.1	Applications.....	3
1.2	Key Features.....	3
1.3	System Requirements.....	4
1.4	OHM-44UHD Shipping Contents.....	4
2	Operation Controls and Functions.....	4
2.1	Front Panel.....	4
2.2	Real Panel.....	5
2.3	Remote Control.....	6
2.4	IR Pin Definitions.....	6
2.5	RS-232 Protocols.....	7
2.6	Telnet and RS-232 Commands.....	7
2.7	Telnet Control.....	9
2.8	WebGUI Control.....	10
3	Connection Diagram.....	17
4.	Specifications.....	18
4.1	Technical Specification.....	18
4.2	Supported Resolution.....	19

1. Introduction

Welcome!

Congratulations on your purchase of HDMI 2.0 4x4 Matrix, OHM-44UHD. This manual contains information that will assist you in installing and operating the product.

Opticis HDMI 2.0 4x4 Matrix, OHM-44UHD, provides a high level of audio and video performance with support for resolutions up to 4K@60Hz (RGB & YCbCr : 4:4:4). It also supports HDR (High Dynamic Range) to deliver more realistic and objective video signal as well as pass-through support of digital audio formats to bring lossless sound. The four (4) HDMI inputs and four (4) HDMI outputs support full matrix switching function with various control methods such as front panel buttons, RS-232, telnet, Web GUI and IR remote. User-friendly WebGUI interface supports storing and recalling up to four routing presets, making remote control and configuration of the unit conveniently. Built in EDID management support allows the users to choose and select from multiple built-in EDIDs as well as to upload custom EDID files and download the EDID from connected displays.

1.1 Applications

- Medical Imaging System
- Video Wall System
- Control Room and Conference Room
- Military, Aerospace, and education
- Digital Signage

1.2 Key Features

- Supports HDMI 2.0 Standards
- Supports HDMI 2.0 resolution up to 4096x2160@60Hz (RGB & YCbCr : 4:4:4)
- Provides user-friendly EDID management tools with 4 slots for user-created EDIDs, and EDID bypass support
- Supports storing and recalling of up to four routing presets
- Controllable via front-panel buttons, RS-232, telnet, WebGUI, and IR remote
- HDCP 1.4 and 2.2 compliant
- Supports HDR at 10 bit or 12 bit speeds respectively within its maximum bandwidth, 18Gbps
- Supports 3D content transmission
- Supports pass-through of LPCM 7.1, bit and HD bit audio formats over HDMI
- Certifies for FCC and CE standards

1.3 System Requirements

- You have to have a HDMI source and a display. In order to be connected, it should support maximum graphic resolution feature of displays.
- No need for special requirements of memory size, CPU speed, or chipsets, if you have already properly installed your HDMI systems or graphic cards
- Initial trail of entire system with Opticis HDMI 2.0 optical extenders or certified HDMI copper cables for long distance transmission are recommended prior to installation of the system.

1.4 Shipping Group

- OHM-44UDS Matrix: 1 EA
- IR Extender: 1 EA
- OTG USB converter: 1 EA
- 24V/2.7A DC Power Adaptor: 1 EA
- IR Remote Control with Battery: 1 EA
- Power Cord: 1 EA
- User Manual: 1 EA

2. Operation Controls and Functions

2.1 Front Panel

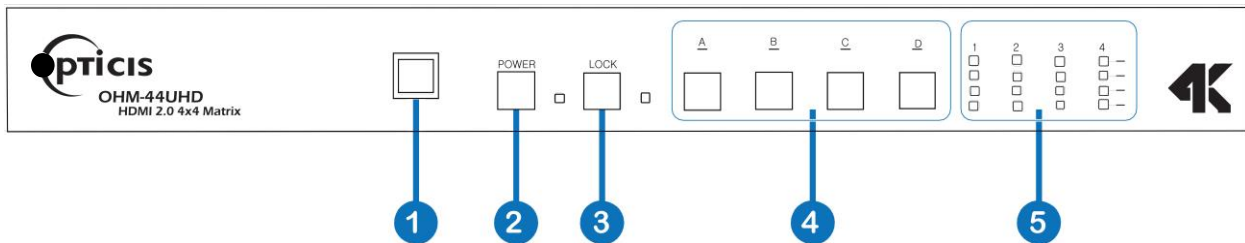

- 1 IR Window:** Receives IR signals from the included IR remote for control of OHM-44UHD unit.
- 2 Power Button & LED:** Press power button to turn OHM-44UHD on (green LED) or place it into stand-by mode (red LED).
- 3 LOCK & LED:** Press to lock all button functions on the front panel. Press and hold for 3 seconds to release the lock function. The LED will be flashing when the front panel is in locked
- 4 A~D:** Press and hold these buttons to switch available inputs for the associated output.
- 5 LED1~4:** These LEDs will be illuminated to indicate which sources are currently selected for each output. No flashing LED for an output that indicates the output is muted.

2.2 Real Panel

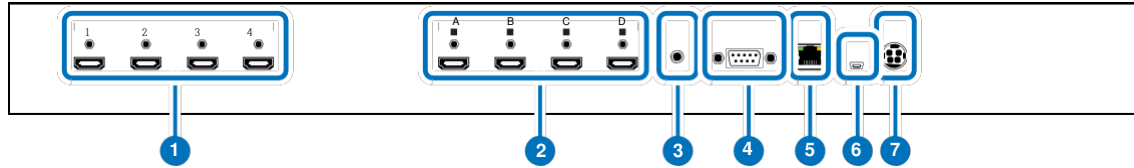

- 1 **INPUT 1~4:** Connect to HDMI display source such as PC, media players or set-top boxes. DVI sources are supported with the use of an HDMI to DVI adapter.
- 2 **OUTPUT A~D:** Connect to HDMI displays such as monitor, TV or amplifiers for digital video.
- 3 **IR IN:** Connect to the provided IR Extender to extend the IR control range of the unit. Ensure that the remote being used is within direct line-of-sight of the IR Extender.
- 4 **RS232:** Connect directly to a PC, laptop or other serial control device to send RS-232 commands to control the unit.
- 5 **Control:** Connect directly, or through a network switch, to your PC/ laptop to control the OHM-44UHD via telnet/WebGUI.
- 6 **SERVICE:** Service slot is reserved for firmware update use only.
- 7 **DC 24V:** Plug the 24V DC power adapter into the unit and connect it to an AC wall outlet for power.

2.3 Remote Control

- 1 POWER:** Press this button to power the unit on or place it into stand-by mode.
- 2 OUTPUT A:** Press the number of the input (1~4) to display on Output A.
- 3 OUTPUT B:** Press the number of the input (1~4) to display on Output B.
- 4 OUTPUT C:** Press the number of the input (1~4) to display on Output C.
- 5 OUTPUT D:** Press the number of the input (1~4) to display on Output D.

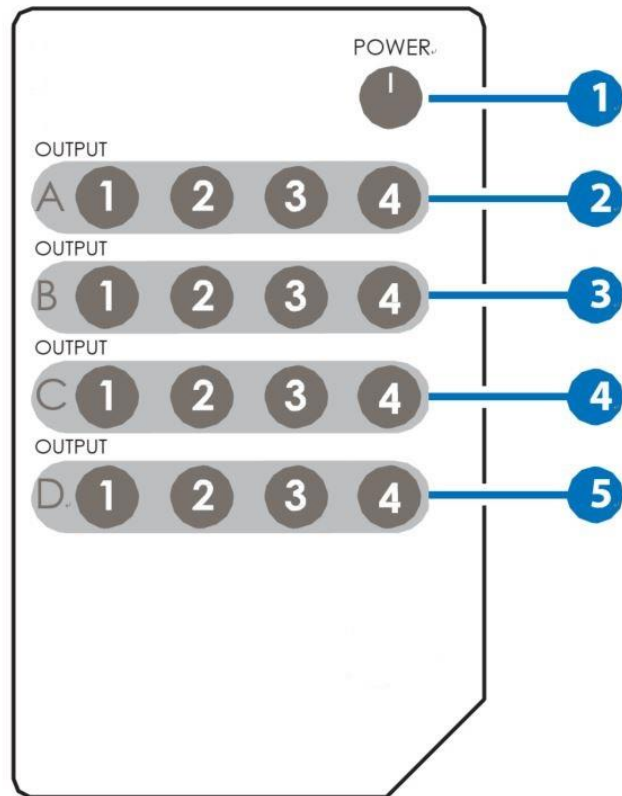

2.4 IR Pin Definitions

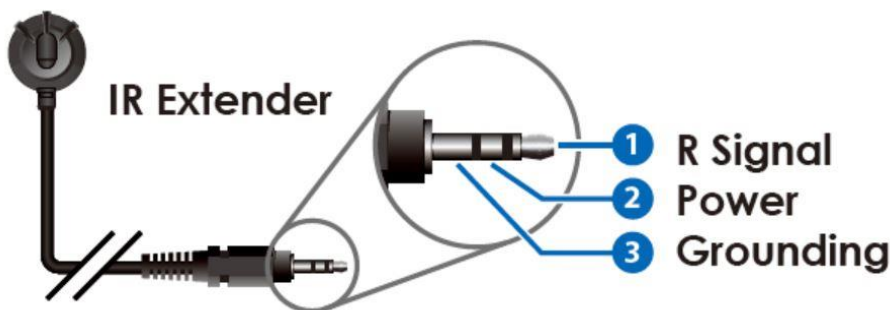

2.5 RS-232 Protocols

MATRIX	
Pin	Definition
1	NC
2	Tx
3	Rx
4	NC
5	GND
6	NC
7	NC
8	Nc
9	NC



REMOTE CONTROLLER	
Pin	Definition
1	NC
2	Rx
3	Tx
4	NC
5	GND
6	NC
7	NC
8	Nc
9	NC

Baud Rate: 115200bps

Data bit: 8 bits

Parity: None

Flow Control: None

Stop Bit: 1

2.6 Telnet and RS-232 Commands

COMMAND	DESCRIPTION	DESCRIPTION OF PARAMETER
A N	Switch Output A to Input N	N= 1~4
B N	Switch Output B to Input N	N= 1~4
C N	Switch Output C to Input N	N= 1~4
D N	Switch Output D to Input N	N= 1~4
I N	Switch All Output to Input N	N= 1~4
AB..... N	Switch output AB....to input N	N= 1~4
SETIP x.x.x.x x.x.x.x x.x.x.x	Setting IP, Subnet, Gateway(Static IP)	X=0~255
IPCONFIG	Display The Current IP Configuration	NONE
RSTIP	Set IP Configuration to DHCP	NONE
P0	Power Off	NONE
P1	Power On	NONE

STORE N	Store Current I/ O to Position N	N= 1~4
SHOW N	Show Current Port N I/O Position	N= 1~4
COMMAND	DESCRIPTION	DESCRIPTION OF PARAMETER
PRESET N	Preset the store I/O Position N	N= 1~4
Name N N1	Name port N as N1	N= 1~4
N1=ABCDEFGH(Max Length=8)		
ST	Show Unit Firmware Version	NONE
EM N N1	Setting port N EDID Mode to N1	N= 1~4 N1= 1-FHD2CH, 2-FHDMCH, 3-4KUHD2CH, 4-4KUHDMCH, 5-4KUHD+2CH, 6-4KUHD+MCH, 7-TXA, 8-TXB, 9-TXC, 10-TXD, 11-USER1, 12-USER2, 13-USER3, 14-USER4
EM? N	Show port N current EDID mode.	N= 1~4
RS	Routing Reset to Default	NONE
USBISP	Update FW by USB	NONE
HELP	Display all available commands and its description	NONE
?	Display all available commands	NONE
QUIT	Quit Telnet	NONE

Note: Commands will not be executed unless followed by a carriage return. Commands are not case-sensitive.

2.7 Telnet Control

The PC/Laptop needs to be connected to the same active networks with OHM-44UHD to use Telnet Control.

- To access Telnet in Windows 7 or 10, click on the “Start” menu and type “cmd” in the search field, then press “Enter”.
- Under Mac OS X, go to Go→Applications→Utilities→Terminal

See below for reference.

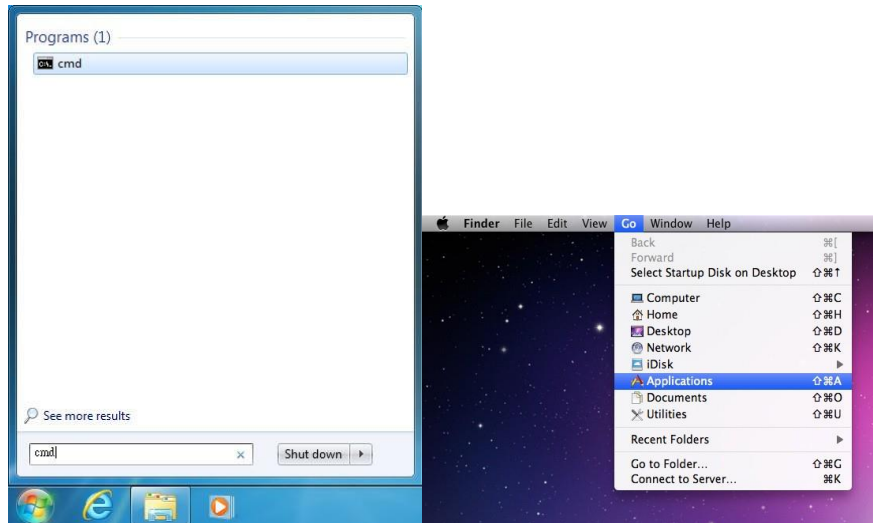

Once in the CLI (Command Line Interface) type “telnet” followed by the IP address of the unit (and the port number if it is non-standard) and then press “Enter”

```
Microsoft Windows [Version 6.1.7601]
Copyright (c) 2009 Microsoft Corporation. All rights reserved.

C:\Users\Administrator>telnet 192.168.5.80 23
```

This will connect us to the unit we wish to control. Type “help” to check the list of available commands.

```
HELP
? : SHOW DESCRIPT OF COMMAND
HELP : SHOW DESCRIPT OF COMMAND
SETIP :SET ETHERNET IP ADDRESS P1 P2 P3 P1=IPADDRESS, P2=NETMASK, P3=GATEWAY(P1-P3)=X.X.X.X (X=0-255)
IPCONFIG : DISPLAY THE CURRENT IPCONFIG
RSTIP : IP CONFIGURATION RESET TO <DHCP>
REBOOT : System Reset
PO : POWER OFF
P1 : POWER ON
STORE : STORE current I/O position (1-4)
SHOW : SHOW current port's I/O position (1-4)
PRESET : PRESET the store I/O position (1-4)
NAME : NAME P1 P2 the stored port P1(1-4) no more than 8 charactors P2 ,Sst PRESET NAME
I1-I4 : SET ALL OUTPUTS SOURCE
ST : SHOW UNIT FIRMWARE VERSION
RS : System Reset to A1,B2,C3,D4
EM : Setting EDID MODE. EM P1 P2. P1=(1-4 PORT) P2=(1-FHD2CH,2-FHDMCH,3-4KUHD2CH,4-4KUHDMMCH,5-4KUHD+2CH,6-4KUHD+MCH,7-TXA,8-TXB,9-TXC,10-TXD,11-USER1,12-USER2,13-USER3,14-USER4)
EM? : Show current EDID mode. EM? P1. P1=(1-4 PORT)
USBISP : Update FW by USB
A1-A4 : SET OUTPUT A SOURCE(1-4)
B1-B4 : SET OUTPUT B SOURCE(1-4)
C1-C4 : SET OUTPUT C SOURCE(1-4)
D1-D4 : SET OUTPUT D SOURCE(1-4)
FADEFAULT : ALL CONFIGURE SET TO FACTORY DEFAULT
AB..1-AB..4 : Switch output ABCD... to 1-4 at the same time
QUIT : Telnet QUIT
```

2.8 WebGUI Control

All primary functions of OHM-44UHD are controllable via the built in WebGUI. This control is presented across 3 separate tabs, including Switch, EDID Settings, and System Settings. The individual functions will be introduced in the following sections.

To obtain device current IP address, you can either use RS232 or by installing Device Discovery Tool. Use current IP to login WebGUI to functions control

- **Install the Device Discovery Tool**

Please obtain the Device Discovery software from your authorized dealer and save it in a directory where you can easily find it.

Note: The unit's default IP address is 192.168.1.50



Connect OHM-44UHD and your PC/Laptop to the same active network and execute the Device Discovery software. Click on "Find Devices on Network" and a list of devices connected to the local network will show up indicating their current IP address.

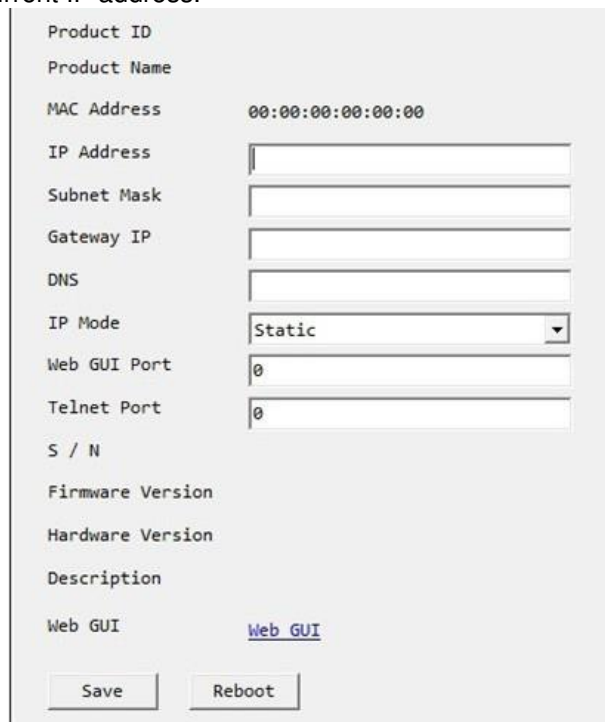

The screenshot shows a network configuration web interface. It contains the following fields and options:

- Product ID
- Product Name
- MAC Address: 00:00:00:00:00:00
- IP Address: [Text Input Field]
- Subnet Mask: [Text Input Field]
- Gateway IP: [Text Input Field]
- DNS: [Text Input Field]
- IP Mode: Static (Dropdown Menu)
- Web GUI Port: 0 [Text Input Field]
- Telnet Port: 0 [Text Input Field]
- S / N
- Firmware Version
- Hardware Version
- Description
- Web GUI: [Web GUI](#)

At the bottom of the form are two buttons: "Save" and "Reboot".

By clicking on one of the listed devices you will be presented with the network details of that particular device. If you choose, you can alter the static IP network settings for the device, or switch the OHM-44UHD into DHCP mode to automatically obtain proper network settings from a local DHCP server. To switch to DHCP mode, please select DHCP from the IP mode drop-down, then click "Save" followed by "Reboot".

Once you are satisfied with the network settings, you may use them to connect via Telnet or WebGUI. The network information window provides a convenient link to launch the WebGUI directly.

• Log in to the WebGUI

To access the WebGUI, open a web browser on a PC/Laptop that is connected to an active network and type the IP address of OHM-44UHD into the web address entry bar. Log into the item by entering the appropriate user name and password.

Note: The default user name and password are “admin”

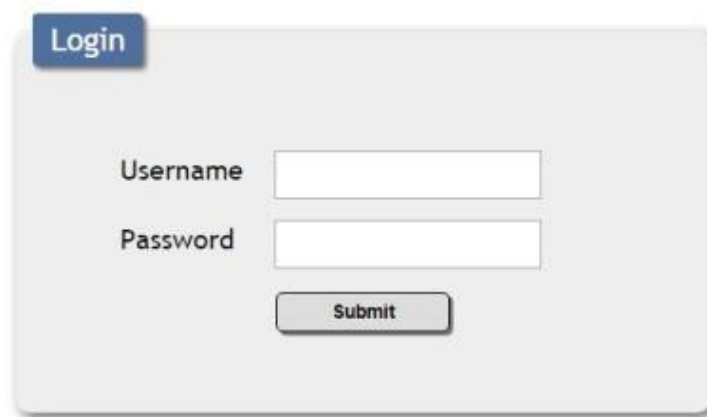

The image shows a login form with a blue 'Login' tab at the top left. Below the tab are two input fields: 'Username' and 'Password'. A 'Submit' button is located below the password field.

• Switch Tab

The Switch tab provides video routing settings, preset saving/loading, and I/O renaming options.

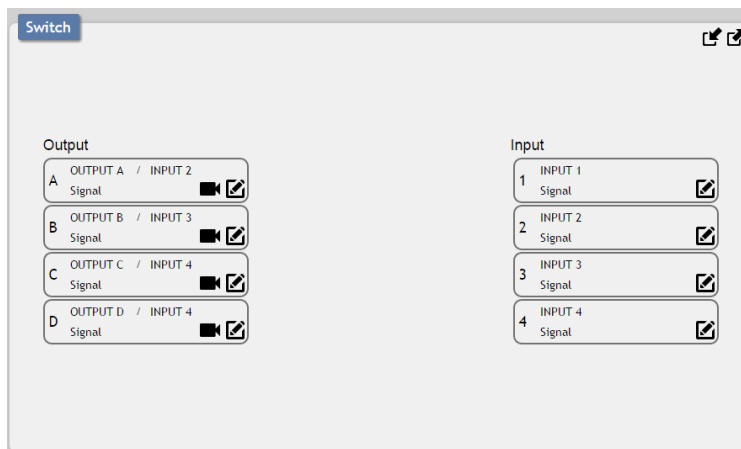

The image shows the 'Switch' tab interface. It has a blue 'Switch' tab at the top left. The interface is divided into two columns: 'Output' and 'Input'. The 'Output' column has four buttons labeled A, B, C, and D. Each button shows a routing configuration: 'A OUTPUT A / INPUT 2 Signal', 'B OUTPUT B / INPUT 3 Signal', 'C OUTPUT C / INPUT 4 Signal', and 'D OUTPUT D / INPUT 4 Signal'. Each button also has a small icon of a monitor and a checkmark. The 'Input' column has four buttons labeled 1, 2, 3, and 4. Each button shows a routing configuration: '1 INPUT 1 Signal', '2 INPUT 2 Signal', '3 INPUT 3 Signal', and '4 INPUT 4 Signal'. Each button also has a small icon of a monitor and a checkmark.

Routing Controls:

To begin assigning a new video route, please click the button of the HDMI output you wish to send video to (e.g. “OUTPUT A”) and then click on the button of the preferred HDMI input port (e.g. “INPUT 3”). As you select each button they will change their color to orange. The new route will become active immediately and the routing information displayed on the buttons will change accordingly.

If you need to route an input to multiple outputs, please select all of the appropriate output buttons before selecting the input port.

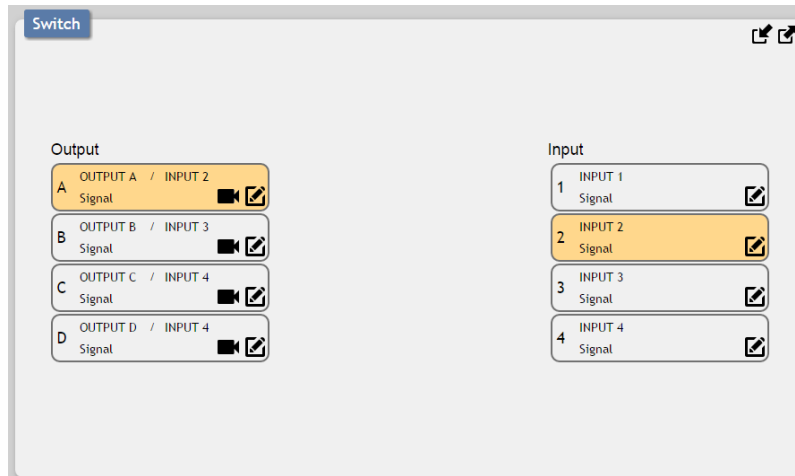

Renaming I/O:

All inputs and outputs can be renamed as required. To rename the HDMI input and output ports please click the “edit” icon (✎). Click the “Save” icon to confirm the change.

Note: Blank spaces (“ ”) are not allowed in names.

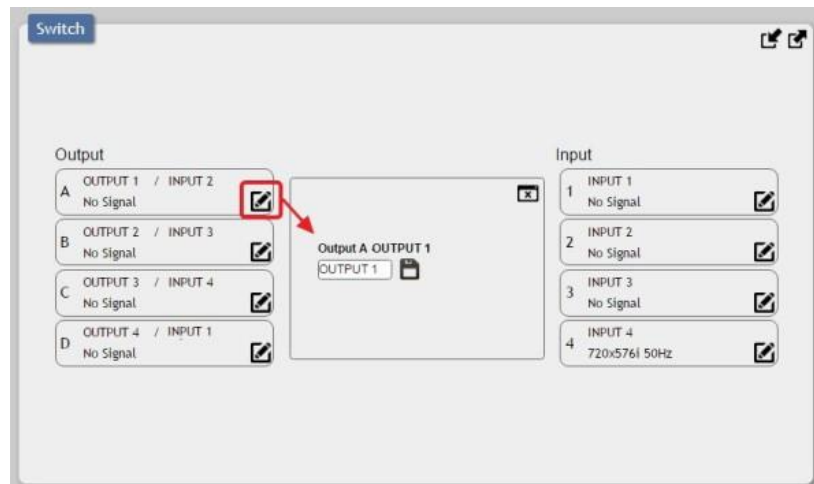

Presets:

OHM-44UHD can store up to 4 routing presets. Presets can be utilized to store multiple different routing states in advance for rapid, hassle-free, recall.

- **Preset Set:** Once you have the matrix set the way you like, you can click the “store” icon (📌) in the upper right corner of the window. You may also name the preset at this stage by selecting the “edit” icon (✎). Click the preset’s button when you are ready to commit the preset to memory.

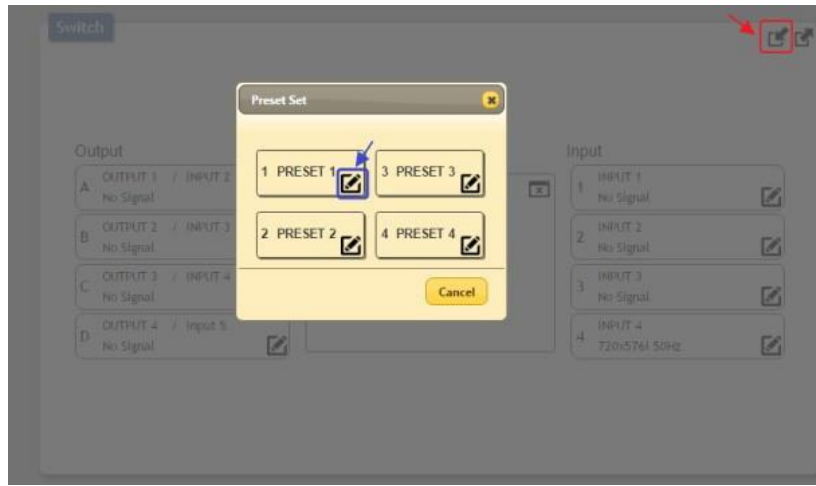

- **Preset Recall:** When you wish to load a previously stored setting, please click the “recall” icon (📌) and you will be presented with a choice of the available 4 presets. The preset will load immediately upon pressing the preset’s button.

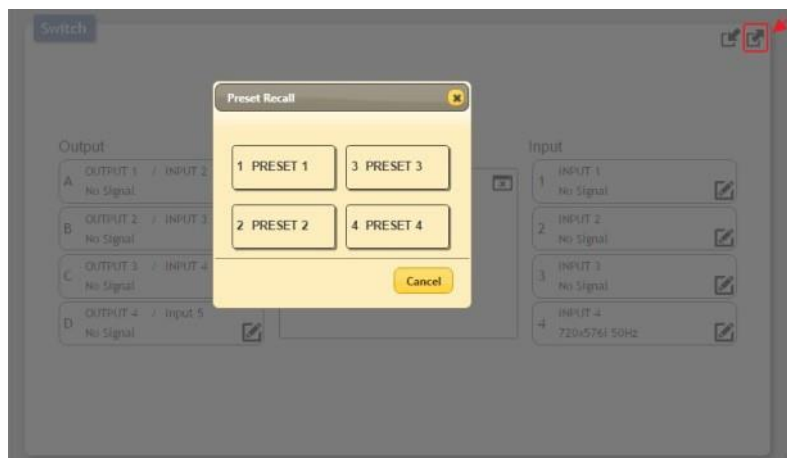

• EDID Settings Tab

OHM-44UHD provides the option of six built in EDIDs, four sink sourced EDIDs and four user uploaded EDIDs that can be assigned to each input port individually. The names of the four user uploaded EDIDs can be changed if desired.

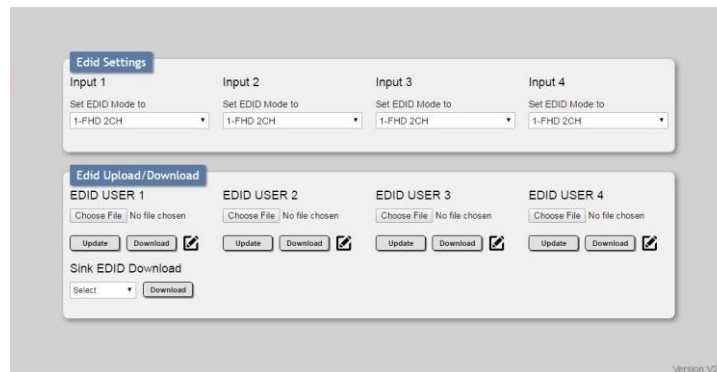

EDID Selection:

The EDID Settings section allows for the assignment of an EDID to each individual input port. Select the preferred EDID from each dropdown menu. The EDID will be changed immediately.

Note: In some rare cases it is possible for custom or external EDIDs to cause compatibility issues with certain sources. If this happens, it is recommended to switch to one of the 6 built in EDIDs for maximum compatibility.

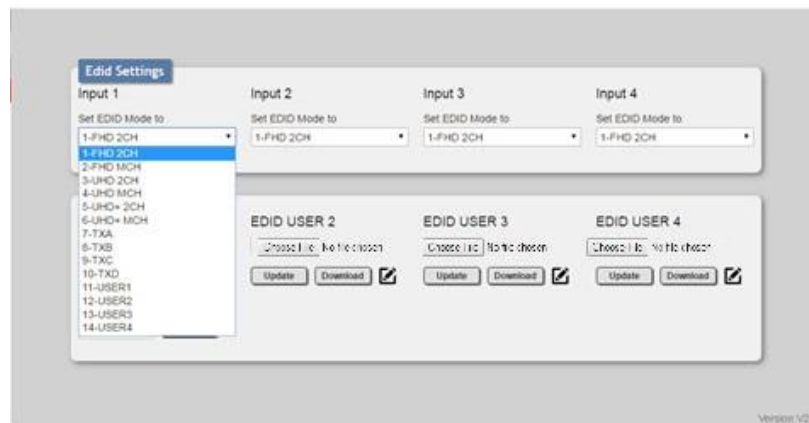

EDID Renaming:

All User EDIDs can be renamed as required. To rename an individual User EDID please click the “edit” icon (✎). Click the “Save” icon to confirm the change.

Note: Blank spaces (“ ”) are not allowed in names.



EDID Upload:

To upload a custom EDID, please click the “Choose File” button below the User EDID that you would like to change. A file selection window will appear, allowing you to locate and upload your preferred EDID file from your local PC. The EDID should be in the *.bin file format. Once the preferred file has been selected, please click the “Update” button, and the file will be transferred to the matrix.

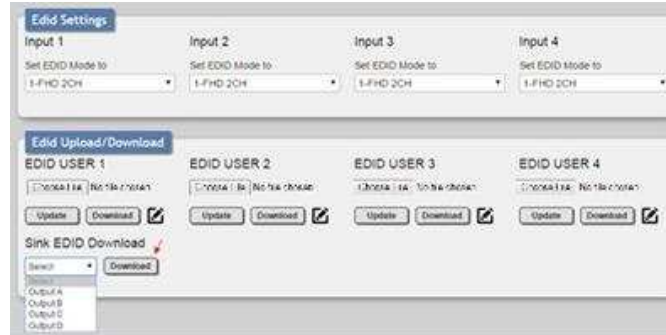

EDID Download:

To save an existing User EDID to your local PC please press the “Down- load” button next to the User EDID that you would like to save. The EDID will then be saved to your local PC as a *.bin file. To save a copy of the EDID from a connected sink, selected the preferred sink from the Sink EDID Download dropdown menu and then press the “Down- load” button next to the selection. The EDID will then be saved to your local PC as a *.bin file.

• System Settings

This page provides system configuration options including turning the power on/off, changing the login password, changing the network settings, resetting the system to factory defaults, and updating the firmware.

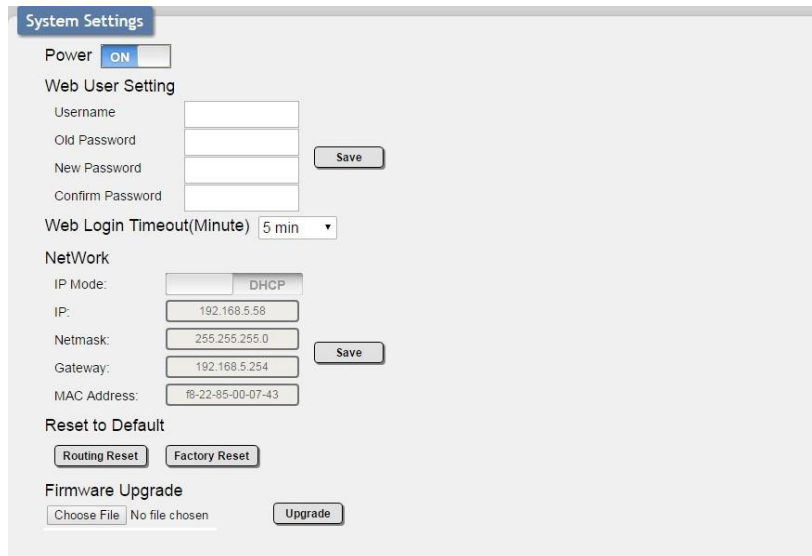

Web User Settings:

To change the login password for OHM-44UHD, enter the username as “admin”, type the current password in the “Old Password” field and then enter the preferred new password in the “New Password” and “Confirm Password” fields. Press “Save” to finalize the change.

Web Login Timeout:

This setting sets the length of idle time to wait before forcing a connected web user to be automatically logged out. Timeout values range from 5 to 60 minutes. To change this timeout value, select a new value from the dropdown and the change will be enforced immediately.

Network:

The IP mode (DHCP or Static IP), IP address, subnet mask, and gateway of OHM-44UHD can be set here. When OHM-44UHD is set to “DHCP” mode, it will automatically attempt to obtain proper configuration information from the local DHCP server. If no DHCP server is available, or the user wishes to configure the network settings manually, please set OHM-44UHD to “Static IP” mode and enter the information as appropriate for your local network. Press “Save” to activate the changes.

Reset to Default:

To reset all routing settings press the “Routing Reset” button. To reset the entire OHM-44UHD to the factory defaults please press the “Factory Reset” button.

The screenshot shows the 'System Settings' page. At the top, there is a 'Power' section with a toggle switch set to 'ON'. Below that is the 'Web User Setting' section with input fields for 'Username', 'Old Password', 'New Password', and 'Confirm Password', followed by a 'Save' button. The 'Web Login Timeout(Minute)' is set to '5 min' via a dropdown menu. The 'NetWork' section includes 'IP Mode' (set to DHCP), 'IP' (192.168.5.58), 'Netmask' (255.255.255.0), 'Gateway' (192.168.5.254), and 'MAC Address' (18-22-86-00-07-43), with a 'Save' button. Under 'Reset to Default', there are two buttons: 'Routing Reset' (highlighted with a red circle) and 'Factory Reset'. The 'Firmware Upgrade' section has a 'Choose File' button, the text 'No file chosen', and an 'Upgrade' button.

Firmware Upgrade:

To update the firmware of OHM-44UHD, press the “Choose File” button to select a new firmware file that is stored on your local PC. After an appropriate file has been selected, press the “Upgrade” button to begin the firmware update process.

3. Connection Diagram

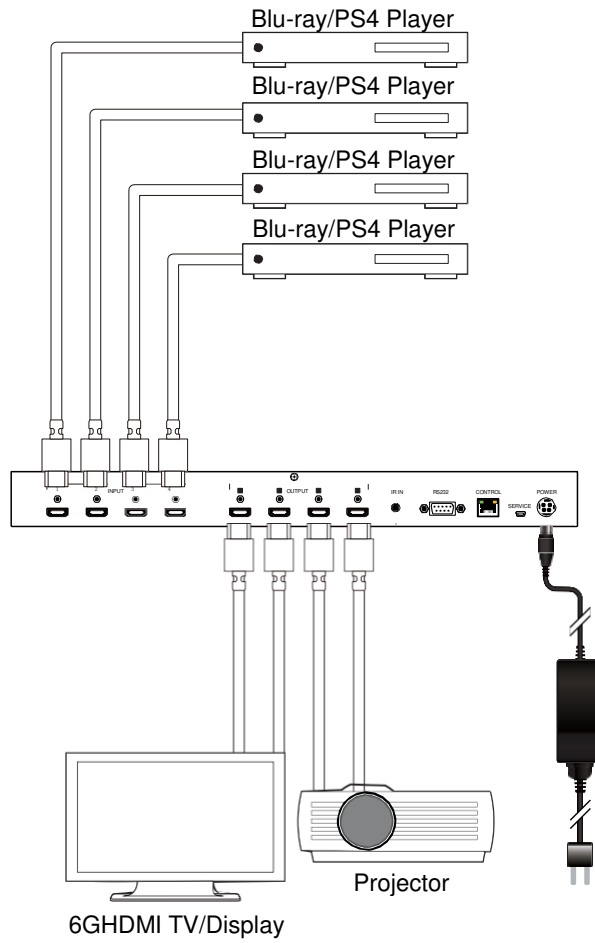

4. Specifications

4.1 Technical Specifications

Video Bandwidth	600MHz/18Gbps
Input Ports	4 x HDMI 1 x IR 1 x RS-232 1 x Mini USB(Service) 1 x RJ45(Control)
Output Ports	4 x HDMI
Supported Resolutions :	480i~1080p@24/50/60Hz 4K up to 4096x2160@60Hz (YUV 4:4:4, 8-bit) VGA~WUXGA
IR Frequency	30~50 kHz
Baud Rate	115200 bps
Power Supply	24VDC/2.7A (US/EU standards, CE/FCC/ UL certified)
ESD Protection	Human body model: ±8 kV (air-gap discharge) ±4 kV (contact discharge)
Dimensions	436 mm x 44 mm x 160mm (W×H×D) [Case Only] 436 mm x 48 mm x 167.5mm(W×H×D) [All Inclusive]
Weight	2068g
Chassis Material	Metal
Color	Black
Operating Temperature	0°C~40°C/32°F~104°F
Storage Temperature	-20°C~60°C/-4°F~140°F
Relative Humidity	20~90% RH (non-condensing)
Power Consumption	21W

4.2 Supported Resolutions (Hz)

DVI and HDMI Supported Resolutions (Hz)	Input	Output
640x480@60/72/75/85	√	√
720x400@85	√	√
800x600@56/60/72/75/85	√	√
1024x768@60/70/75/85	√	√
1152x864@75	√	√
1280x720@60	√	√
1280x768@60/75/85	√	√
1280x800@60	√	√
1280x960@60	√	√
1280x1024@60	√	√
1360x768@60	√	√
1366x768@60	√	√
1400x1050@60	√	√
1440x900@60	√	√
1600x900@60	√	√
1600x1200@60	√	√
1680x1050@60	√	√
1920x1080@60	√	√
1920x1200@60	√	√
1920x1440@60	√	√
2560x1600@60	√	√
1440x576i@50	√	√
1440x480i@59.94/60	√	√
720x480p@59.94/60	√	√
720x576p@50	√	√
1280x720p@50/59.94/60	√	√
1920x1080i@50/59.94/60	√	√
1920x1080p@23.97/24/25/29.97/30/50/59.94/60	√	√
3840x2160@24/25/30/50/60	√	√
4096x2160@24/25/30/50/60	√	√

© 2019 Opticis Co., Ltd. All Rights Reserved
Version 1.0 September 2019

NO	Date	Content	Remark
0	2019.09	First released	